



**UNIVERSITY OF LEEDS**

**DFID** Department for  
International  
Development

| G | H | K |

**DFID**

**PC-based  
Simplified  
Sewer Design**

**Duncan Mara**

**Andrew Sleigh**

*School of Civil Engineering*

*University of Leeds*

and

**Kevin Tayler**

*GHK Research & Training*

London

January 2001

First published in 2001 by the School of Civil Engineering,  
University of Leeds, LEEDS LS2 9JT, England.

© University of Leeds, 2001

All rights reserved.

No part of this publication may be reproduced, stored in any retrieval system, or transmitted, by any form or by any means, electronic, mechanical, photocopying, recording or otherwise, without prior permission of the copyright owner.

ISBN 0-904280-01-2

British Library Cataloguing-in-Publication Data. A catalogue record for this book is available from the British Library.

*DISCLAIMER*

The University of Leeds, GHK Research & Training and the Department for International Development bear no responsibility for, and are not in any way committed to, the views and recommendations contained in this Manual.



---

# Contents

**Preface** *v*

**Acknowledgements** *vii*

**Abbreviations and Principal Notation** *viii*

**About this Manual** *ix*

**1. Introduction 1**

- 1.1 The need for sanitation 1
- 1.2 Simplified sewerage 3
- 1.3 Promotion of simplified sewerage 9

**2. Theory of Simplified Sewerage 11**

- 2.1 Wastewater flow 11
  - 2.1.1 Minimum daily peak flow 12
- 2.2 Properties of a circular section 12
- 2.3 Gauckler-Manning equation 15
- 2.4 Tractive tension 15
- 2.5 Minimum sewer gradient 16
- 2.6 Sewer diameter 17
- 2.7 Number of houses served 18
- 2.8 Design comparisons 19

**3. Planning and Design 21**

- 3.1 Initial assessment of sanitation options 21
  - 3.1.1 Technical options 22
  - 3.1.2 Management options 23
- 3.2 Planning for sewerage 24
  - 3.2.1 Collection of existing information 25
  - 3.2.2 Area to be included 25
  - 3.2.3 Development of a draft sewerage plan 26
  - 3.2.4 Physical and social surveys 27
  - 3.2.5 Final sewer routes 29
- 3.3 Detailed design 29
  - 3.3.1 Introduction to the design process 29
  - 3.3.2 Categories of design parameters 30
  - 3.3.3 Design input parameters 30
  - 3.3.4 Design over-riding parameters 32
  - 3.3.5 Design output parameter – minimum sewer gradient 33
  - 3.3.6 Design of condominium sewers 34
  - 3.3.7 Design of public collector sewers 39

- 4. PC-based Simplified Sewer Design 41**
  - 4.1 Overview 41
    - 4.1.1 System requirements 41
    - 4.1.2 Obtaining the program 41
    - 4.1.3 The definition of a sewer network used in the program 42
    - 4.1.4 The minimum information necessary to use the program 42
    - 4.1.5 Getting started 42
  - 4.2 Visual editor screen 44
  - 4.3 Data entry/edit screen 52
  - 4.4 Results table screen 56
  - 4.5 Calculator screen 59
  - 4.6 Main menu options 62
    - 4.6.1 File menu 62
    - 4.6.2 View menu 63
    - 4.6.3 Option menu 64
    - 4.6.4 Tools menu 65
    - 4.6.5 Help menu 66
  - 4.7 Quick Start examples 66
    - 4.7.1 Example 1 – A single line of sewers 67
    - 4.7.2 Example 2 – Adding a branch sewer 74
    - 4.7.3 Example 3 – Branch conversion to two sub-networks 76
    - 4.7.4 Example 4 – The UNCHS design example 79

## **5. Simplified Sewerage in Practice 81**

- 5.1 Simplified sewer construction 81
  - 5.1.1 The need for good construction practice 81
  - 5.1.2 Sewer gradient and ground slope 81
  - 5.1.3 Grease/grit traps 84
  - 5.1.4 Sewer pipe materials 85
  - 5.1.5 Sewer appurtenances 85
- 5.2 Operation and maintenance 87
- 5.3 System sustainability 89

## **References and Further Reading 91**

- Publications available on the Internet 96

## **Appendix 1. Velocity of Flow Equations 97**

- A1.1 The Chézy equation 97
- A1.2 The Gauckler-Manning equation 98
  - A1.2.1 Dimensions of  $n$  98
  - A1.2.2 A modern form for the Gauckler-Manning equation 100
- A1.3 The Colebrook-White equation 100
- A1.4 The Escripp equation 101

## **Appendix 2. Comparative Simplified Sewer Design Trials 103**

- A2.1 UNCHS design example 103
- A2.2 World Bank – UNDP design example 104

## **Appendix 3. Hydrogen Sulphide Generation 109**

---

# Preface

Simplified sewerage is an important sanitation option in peri-urban areas of developing countries, especially as it is often the only technically feasible solution in these high-density areas. It is a sanitation technology widely known in Latin America, but it is much less well known in Africa and Asia. It is the purpose of this Manual to disseminate this technology more widely in the developing world, so that it can be used in peri-urban sanitation programmes and project to improve the health of poor communities. However, simplified sewerage is not just for peri-urban areas – it can be successfully and appropriately used in middle-and upper-income areas as well.

We hope that this Manual serves its purpose of making simplified sewerage better known throughout the developing world, and that the PC-based design program contained herein facilitates the hydraulic design calculations.

**Duncan Mara**  
**Andrew Sleigh**  
**Kevin Tayler**  
*December 2000*





---

# Acknowledgements

We are grateful to the UK Department of International Development for its generous financial support for this Manual. In particular we wish to express our thanks to Mr Ian Curtis, Senior Water Adviser, and Mr Jeremy Ockleford, Consultant Engineering Adviser for Water Supply and Sanitation, Infrastructure and Urban Development Department for their general support and their very helpful comments on the early drafts of this Manual.

In Brazil we wish to express our gratitude to several colleagues: Augusto Sérgio Guimarães, GAIA Engenharia Ltda, Rio de Janeiro RJ; Professor Cicero Onofre Neto, Universidade Federal do Rio Grande do Norte, Natal RN; Dr Maurício Ludovice, CAESB, Brasília DF; and Celso Savelli Gomes, SANEPAR, Curitiba PR.

In Kenya, where the PC-based design procedure was extensively fieldtested, we are very grateful to Dr Graham Alabaster, UNCHS, Nairobi and to the following who evaluated the PC-based design procedure during a Workshop held in Nairobi in May 2000: Eng. N.N. Nyariki, Eng. H.A. Jirma, Eng. E. Kamau and Mr G.G. Kanyi (Urban Development Department, Ministry of Local Government, Nairobi), Mr Lander J. Ocio (MSc student, Department of Civil and Environmental Engineering, University of Newcastle upon Tyne), and Mr Harrison Kwach (consultant, UNCHS, Nairobi).

---

# Abbreviations

ABES	Brazilian Association of Sanitary and Environmental Engineering
BOD <sub>5</sub>	Five-day, 20°C Biochemical Oxygen Demand
CAERN	Water and Sewerage Company of the State of Rio Grande do Norte
CAESB	Water and Sewerage Company of the Federal District
COMPESA	Water and Sewerage Company of the State of Pernambuco
SABESP	Water and Sewerage Company of the State of São Paulo
SANEPAR	Water and Sewerage Company of the State of Paraná

---

# Principal Notation

<i>a</i>	Area of flow, m <sup>2</sup>
<i>A</i>	Area of flow at $d/D = 1$ , m <sup>2</sup>
<i>C</i>	Depth of cover of sewer, m
<i>d</i>	Depth of flow, m
<i>D</i>	Sewer diameter, m or mm
<i>g</i>	Acceleration due to gravity, m/s <sup>2</sup>
<i>h</i>	Depth of sewer invert, m
<i>i</i>	Sewer gradient, m/m
<i>I<sub>min</sub></i>	Minimum sewer gradient, m/m
<i>k<sub>a</sub></i>	Area of flow proportionality constant
<i>k<sub>r</sub></i>	Hydraulic radius proportionality constant
<i>k<sub>1</sub></i>	Peak flow factor
<i>k<sub>2</sub></i>	Return factor
<i>l, L</i>	Sewer length, m
<i>n</i>	Ganguillet-Kutter (or Manning) roughness coefficient
<i>p</i>	Wetted perimeter, m
<i>P</i>	Population served
<i>q</i>	flow, m <sup>3</sup> /s or l/s
<i>r</i>	Hydraulic radius, m
<i>R</i>	Hydraulic radius at $d/D = 1$ , m
<i>S</i>	Ground slope, m/m
<i>v</i>	Velocity of flow, m/s
<i>w</i>	Water consumption, l/person d
<i>W</i>	Weight, N
<b>Z</b>	Pomeroy's factor for H <sub>2</sub> S generation
<i>θ</i>	Angle of flow, radians
<i>ρ</i>	Density of wastewater, kg/m <sup>3</sup>
<i>τ</i>	Tractive tension, N/m <sup>2</sup> (Pa)
<i>φ</i>	Angle of sewer gradient, radians

---

# About this Manual

Section 1.1 discusses the need for sanitation in periurban areas, and Section 1.2 introduces the concept of simplified sewerage, especially its development and dissemination in Brazil. Ideas for promoting simplified sewerage in countries with no previous experience of the technology are given in Section 1.3.

The theory of simplified sewerage is presented in the Section 2. Section 2.1 discusses the design value to be used for the wastewater flow, in particular the design values for the peak factor and the return factor. Section 2.2. sets out the properties of a circular section, and Section 2.3 gives the Gauckler-Manning equation for the velocity of flow. Section 2.4 presents the hydraulic design based on minimum tractive tension; as shown in Section 2.5, this leads to the calculation of the minimum sewer gradient, and the procedure for calculating the sewer diameter is given in Section 2.6. The maximum number of households of a given size and a given water consumption that can be served by a simplified sewer of given diameter is discussed in Section 2.7. Section 2.8 and Annex II detail simplified sewer design trials using the Gauckler-Manning, Colebrook White and Escribano equations (which are described in Annex I).

Section 3 details the planning, management and design aspects of simplified sewerage. Technical and management options are discussed in Section 3.1, and sewerage planning in Section 3.2. Design parameters are considered in Section 3.3, which also details the design of condominial sewers and that of public collector (or street) sewers.

Section 4 describes the use of the Windows-based computer program developed for simplified sewer design. This program is contained on the CDROM enclosed with this Manual. It is also available as “shareware” on the Internet at the following URL (which is case sensitive):

<http://www.efm.leeds.ac.uk/CIVE/Sewerage>

The program will run on any of the following Windows-based operating systems:

- Windows 95
- Windows 98
- Windows 2000
- Windows NT

but it will **not** run on Windows 3.1. The hardware requirements are minimal: any PC capable of running one of the above versions of Windows will run this program.

Finally, Section 5 describes the more practical aspects of simplified sewerage. Construction details are considered in Section 5.1, and arrangements for operation and maintenance in Section 5.2. Overall system sustainability is briefly summarised in Section 5.3.

# 1

---

## Introduction

### 1.1 THE NEED FOR SANITATION

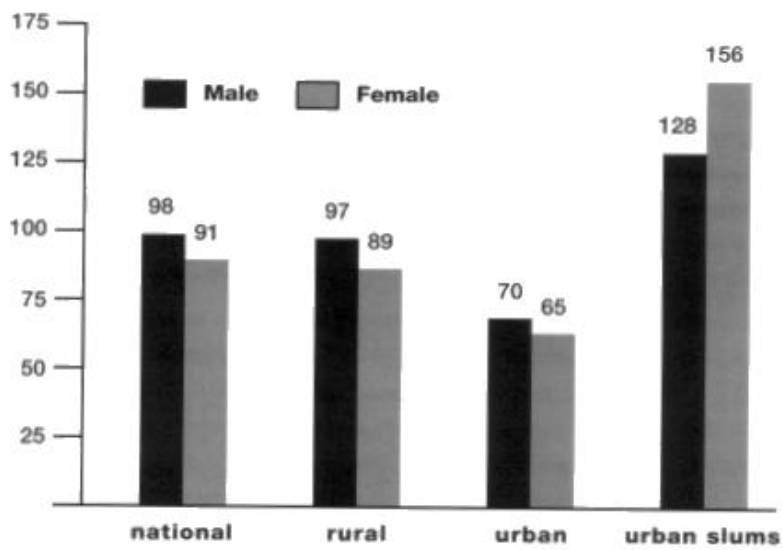
Low-income communities which do not have adequate sanitation facilities are exposed to a high risk of infection with excreta-related diseases. Children under the age of 3 are particularly susceptible to diarrhoeal diseases. Older children and adults are likely to be infected with intestinal worms, most commonly the human roundworm (*Ascaris lumbricoides*) and the human hookworms (*Ancylostoma duodenale* and *Necator americanus*). This disease burden is generally very high in low-income periurban communities: Figure 1.1 shows that infant mortality in Bangladesh, for example, is higher in periurban areas than in rural areas; and Figure 1.2 shows that, both infant and adult mortality in urban Brazil is higher in poor areas than in non-poor areas.

There is an acute need for sanitation in poor periurban areas. Sanitation is the key infrastructure component which is required to reduce the unacceptably heavy toll of excreta-related disease. Yet sanitation coverage in urban areas is currently decreasing (Table 1.1), and urbanization – actually periurbanization – is increasing. In many (but obviously not all) periurban situations the sanitation technology of first choice is simplified sewerage. The two principal reasons for this, which are explained more fully in Section 1.2, are that it can be cheaper than on-site sanitation systems, and that it is often institutionally easier – that is to say, water and sewerage authorities accept it more readily than on-site systems simply because it is a sewerage system and therefore automatically part of their mindset.

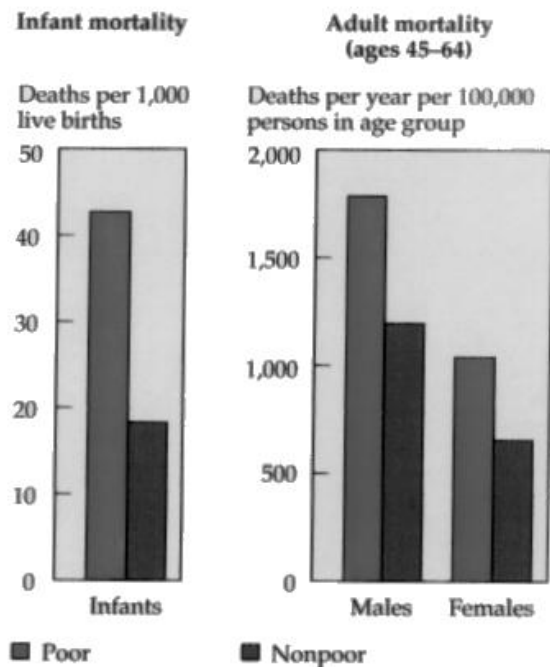
**Table 1.1 Urban Population (millions) Unserved with Sanitation, 1990 and 1994**

Region	1990	1994	% Increase
Africa	71	108	52.1
LAC	52	94	80.8
Asia Pacific	316	371	17.4
World	453	589	30.0

Source: WHO (1996).



**Figure 1.1** Infant mortality in Bangladesh in 1991. *Source:* UNICEF Bangladesh (1993), cited in Black (1994).



**Figure 1.2** Infant and adult mortality in poor and non-poor areas of Porto Alegre in southern Brazil in 1980. *Source:* World Bank (1993).

## 1.2 SIMPLIFIED SEWERAGE

Simplified sewerage is an off-site sanitation technology that removes all wastewater from the household environment. Conceptually it is the same as conventional sewerage, but with conscious efforts made to eliminate unnecessarily conservative design features and to match design standards to the local situation.

Various approaches to reduced-cost sewerage have been developed in different parts of the world, often independently of each other. This Manual draws on the approach developed in the early 1980s by the CAERN, the Water and Sewerage Company of the northeastern Brazilian state of Rio Grande do Norte. The aim of CAERN was to develop a technically feasible and socio-culturally acceptable solution to the previously intractable problem of sanitation provision in high-density low-income peri-urban areas (de Andrade Neto, 1985; Guimarães, 1986; Mara 1996; de Melo, 1994; Sinnatamby, 1983 and 1986; Sinnatamby *et al.*, 1986). The simplified sewerage approach is now widely used through Brazil (Box 1.1).

Key features of the system are as follows:

- (a) **Layout:** in order to reduce costs, CAERN developed simplified sewerage as an *in-block* system (Figure 1.3), rather than – as with conventional sewerage – an in-road system. The key feature of an in-block system is that sewers are routed in private land, through either back or front yards. This in-block or back-yard system of simplified sewerage is often termed **condominial sewerage** in recognition of the fact that tertiary sewers are located in private or semi-private space within the boundaries of the 'condominium'.
- (b) **Depth and diameter:** simplified sewers are laid at shallow depths, often with covers of 400 mm or less (see Section 5.1.2). The minimum allowable sewer diameter is 100 mm, rather than the 150 mm or more that is normally required for conventional sewerage. The relatively shallow depth allows small access chambers to be used rather than large expensive manholes (see Section 5.1.5).

In-block systems of the type recommended by CAERN are not possible in all situations. For instance, there are many places where house construction extends to both the front and back of the plot, thus preventing a sewer from being routed through the plot. Even where this is not the case, householders may be reluctant to allow sewers to be routed through their plots. Other options have been developed in such situations to allow sewers to be laid at shallow depths. These include *lane sewers* laid in access ways that are too narrow to allow heavy traffic, and *pavement sewers* laid underneath pavements (sidewalks) to avoid the heaviest traffic loading (Figure 1.4). Most low-income areas do not have pavements. Where this is the case a variation in the form of *plot line sewers* may be appropriate. In essence, the principle is the same as that for the pavement sewer: the sewer is laid at shallow depth close to the front boundary of plots, which will often also be the building line.

### Box 1.1 The development and dissemination of simplified sewerage in Brazil

Simplified sewerage – generally known as condominium sewerage in Brazil – was developed by the R&D Division of CAERN, the water and sewerage company of the northeastern State of Rio Grande do Norte, and its engineering consultant José Carlos de Melo, with technical assistance being provided by Professor Cicero Onofre de Andrade Neto of the department of Civil Engineering of the Federal University of Rio Grande do Norte. It was fieldtested in the low-income areas of Rocas and Santos Reis in Natal, the State capital in the early 1980s. The CAERN team presented its experience at the biennial Congress of the Brazilian Association of Sanitary and Environmental Engineering (ABES) held in Balneário Camboriú, Santa Catarina in November 1983, and also described the system in the ABES technical journal *Engenharia Sanitária* (de Andrade Neto, 1985; de Melo, 1985).\*

CAERN's development of condominium sewerage in Natal was partially funded by the World Bank Medium Sized Cities project, which also saw the implementation of condominium sewerage in the city of Petrolina in the state of Pernambuco. In Natal the Brazilian Office of the World Bank/UNDP Technology Advisory Group (TAG) (project GLO/78/006, later INT/81/047) evaluated the Rocas and Santos Reis scheme. This led to the production of the Brazilian national design manual for simplified sewerage (Guimarães, 1986) and the formation of the ABES Low-cost Sanitation Committee (1984-1986), which in turn led to the adoption of a minimum sewer diameter of 100 mm in the revision of the Brazilian national sewerage design code (ABNT, 1986) (previously it was 150 mm). A further key feature in the development of simplified sewerage design in Brazil was the realisation by the late Brazilian sanitary engineer Eugênio Macedo that the sewer gradient should be based on the initial design flow and the sewer diameter on the final design flow – an important consideration (incorporated into the 1975 Brazilian national sewerage design code) as in low-income areas the latter may be up to five times the former.

Simplified sewerage schemes were then implemented by several of the Brazilian state water and sewerage companies (see Watson, 1995). SANEPAR and SABESP, the water and sewerage companies of the southern states of Paraná and São Paulo, introduced front-yard and pavement sewerage (laying the sewer in the front garden and sidewalk), rather than backyard (in-block) sewerage as used in the northeast of the country, and they changed the hydraulic design basis from minimum self-cleansing velocity to minimum tractive tension (Machado Neto and Tsutiya, 1985), a change which was also included in the 1986 Brazilian national sewerage design code.

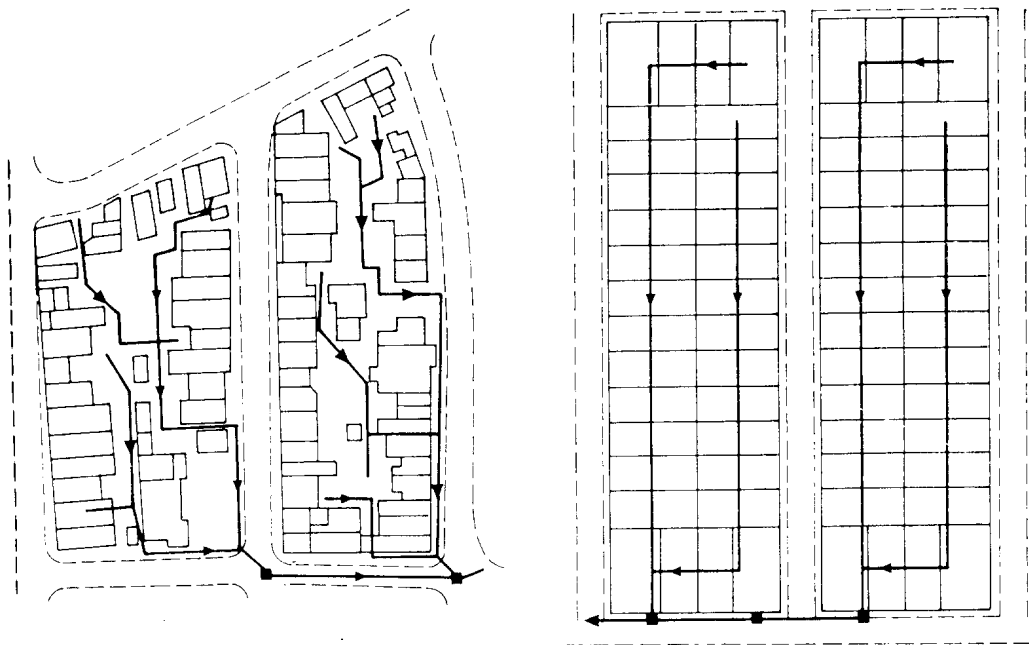
CAESB, the water and sewerage company of Brasília and the Federal District, started implementing simplified sewerage in poor areas in 1991 and now it considers simplified sewerage as its “standard solution” for rich and poor areas alike (see Figure 1.6). CAESB has over 1,200 km of condominium sewers in operation – the largest example of simplified sewerage in the world. Average capital costs are around R\$ 40-60 (US\$ 22-34) per person (Luduvic, 2000).

Simplified sewerage is now used in many states in Brazil. Many schemes have been successful, and some have been failures – mainly due to poor construction and/or poor institutional commitment (see Watson, 1995), and especially due to poor maintenance. Whatever the successes and failures of individual projects, what can be said is that simplified sewerage has been successfully adopted into mainstream Brazilian sanitary engineering. The reasons for this success have been (1) the ease of dissemination of innovative technologies at the biennial ABES Congresses which are attended by all the state water and sewerage companies, (2) the relatively small number of leading Brazilian sanitary engineers who have been committed to, and have been excellent advocates of, the technology, and (3) the keen interest shown in the technology since its beginning by the World Bank and UNDP which has acted within Brazil to give the system a seal of international approval.

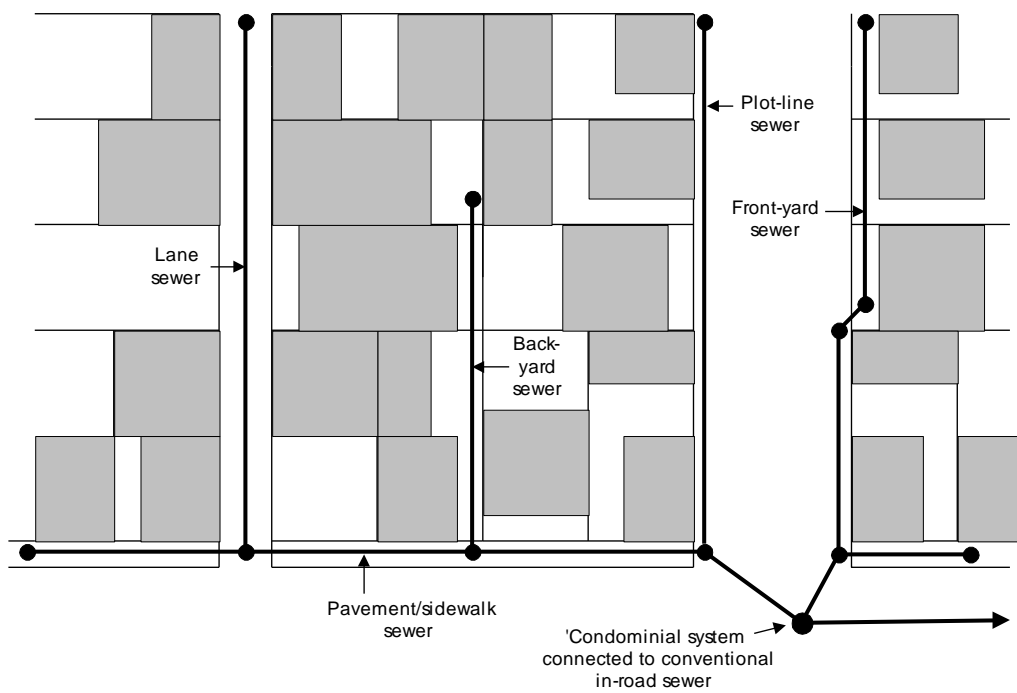
\* Dr Gehan Sinnatamby, then a doctoral student from the University of Leeds, England was part of the CAERN R&D team and this led to dissemination of condominium sewerage outside Brazil, including the production of the UNCHS Design Manual (see Sinnatamby, 1983 and 1986; Sinnatamby *et al.*, 1986).



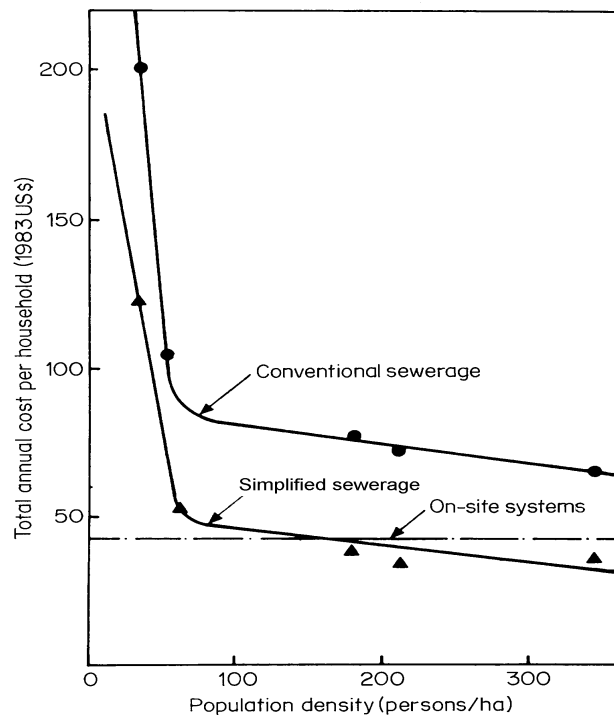
Figure 1.4 illustrates the way in which all these different types of sewer can be used. This is a theoretical example and it will be unusual for all the possible arrangements to be used together in the way shown in the figure. The key question to be answered by the designer and householders in the area to be sewered is which form (or forms) of condominial sewer will be most suitable for the local situation.



**Figure 1.3** Layouts of in-block simplified (condominial) sewerage for unplanned and planned periurban housing areas. *Source:* Sinnatamby (1983).



**Figure 1.4** Alternative routes for simplified sewers.



**Figure 1.5** Costs of conventional and simplified (condominial in-block) sewerage, and on-site sanitation in Natal in northeast Brazil in 1983. *Source:* Sinnatamby (1983).



**Figure 1.6** In-pavement (sidewalk) simplified sewerage being installed in the high-income area of Lago Sul in Brasília in 1999.

In-block sewerage, particularly back-yard sewerage, can significantly reduce the length of sewer required, thus reducing costs. Costs are further reduced by laying sewers at shallow depths away from heavy traffic loads. The results are illustrated in Figure 1.5, which shows that, as the population density increases, simplified sewerage can become cheaper than on-site sanitation systems. In Natal, the state capital of Rio Grande do Norte, this occurred at the relatively low peri-urban population density of 160 persons per hectare.

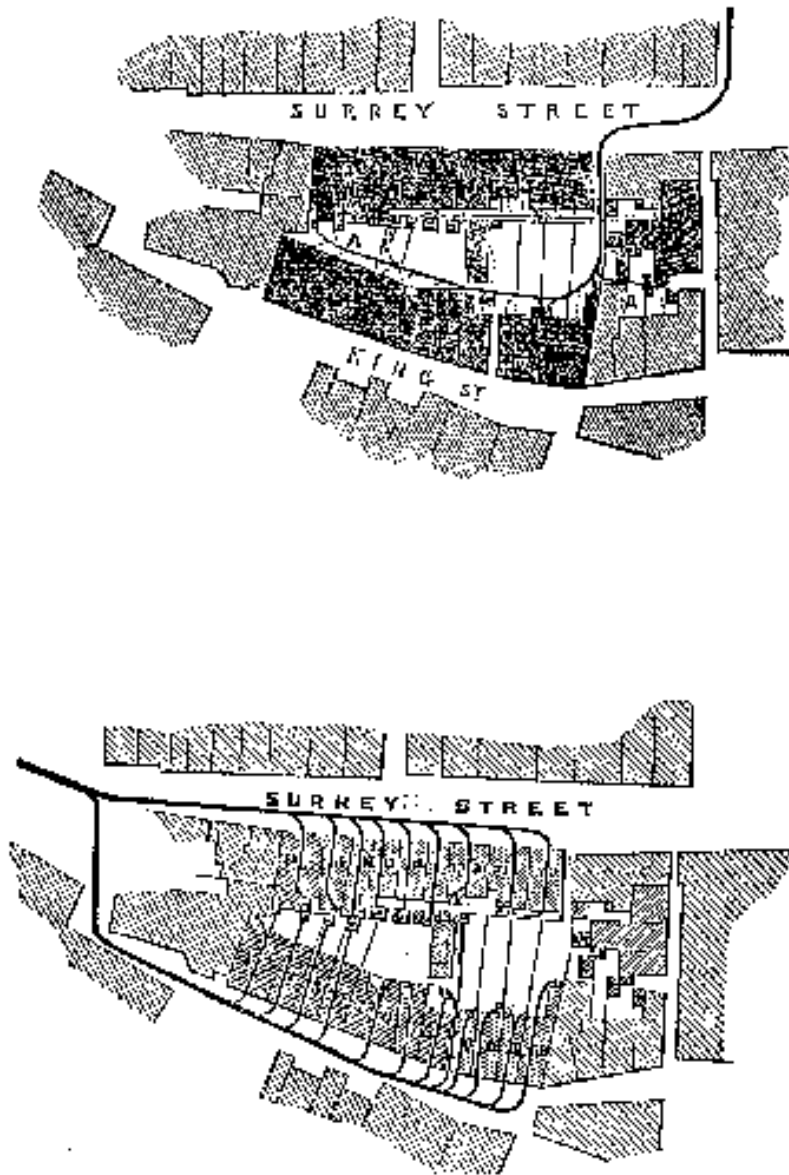
In Natal, the capital costs of simplified sewerage in 1980 were US\$ 325 per household, compared with around US\$ 1,500 per household for conventional sewerage. CAERN was able to recover its costs over a 30-year period by surcharging the monthly water bill by only 40%, rather than the 100% that was the norm for conventional sewerage. The monthly charge for water was US\$ 3.75, the 'minimum tariff', based on an assumed unmetered consumption of 15 m<sup>3</sup> per household per month. Thus, the cost of simplified sewerage to the householder was only US\$ 1.50 per month.

Similar levels of cost saving have been recorded elsewhere. In Orangi, Pakistan, the cost of community-based sewerage installed with technical assistance from the Orangi Pilot Project (OPP) was found to be about one quarter of that of conventional sewerage provided by government agencies (see Reed and Vines, 1992a, b and Zaidi, 2000). At around \$40 per household, the absolute costs of these sewers was much lower than in northeast Brazil. This was partly because of much lower construction costs and partly because the sewers were built by the users themselves. Regardless of the absolute cost, the important point is that simplified sewerage offers substantial costs savings over conventional sewerage and is thus more likely to be affordable to the urban poor.

The fact that simplified sewerage is low-cost does not mean that it can only be used in low-income peri-urban areas. CAESB, the water and sewerage company of Brasília and the Federal District in Brazil, now regards simplified sewerage as its standard solution for sanitation in rich and poor areas alike (Luduvicé *et al.*, 1999; see also Nigreiros, 1998). This preference for simplified sewerage must be seen in the context that rich areas of Brasília are very rich indeed (Figure 1.6).

Simplified sewerage has been successfully used in countries other than Brazil. In Latin America, for example, it is used in Bolivia, Colombia, Nicaragua, Paraguay and Peru (Guimarães, 2000). In Africa it has been implemented in a few trials in South Africa (Pegram and Palmer, 1999), and in Asia it has been very successfully used since the mid-1980s by the National Housing Development Authority in Sri Lanka, with over 20 schemes now in operation (Ganepola, 2000); it has also been used in Karachi, Pakistan (Sinnatamby *et al.*, 1986) (Box 1.2) and Malang, Indonesia (Foley *et al.*, 2000). In India, however, and despite the technology being included in the national sewerage and sewage treatment design manual (Ministry of Urban Development, 1995), it has not been used, even though its applicability is very high, especially in "slum networking" sewerage projects (see Diacon, 1997; see also Chaplin, 1999).

Interestingly condominial (back-yard) sewerage is not new: it was recommended in the United Kingdom 150 years ago (General Board of Health, 1852; Mara, 1999) (Figure 1.7).



**Figure 1.7** In-block sewerage (top) and conventional sewerage (bottom) in Victorian England. *Source:* General Board of Health (1852).

### Box 1.2 The introduction of simplified sewerage into Pakistan

“Simplified sewers were introduced to Pakistan in early 1985. Christy Nagar, a low-income Bihari community on the outskirts of Karachi, was selected for a demonstration project. The population density is 193 persons per ha, and most households obtain an intermittent supply of water from public standpipes: water consumption is low, only some 27 litres per person per day. Simplified sewers, designed as in Brazil, receive the wastewater from manually flushed squat pans and also all the household sullage; a grit and grease trap is provided which acts as a focus for sullage collection and also serves as a preventive maintenance device. Despite the low flows, the system has functioned perfectly well for nearly a year: no blockages have occurred, showing that properly designed sewers do not need vast quantities of water for trouble-free operation. The investment cost per household was incredibly low – a mere \$45, which covered the squat pan, grit and grease trap, house connection, street laterals, collector main and primary treatment.”

Source: Sinnatamby *et al.* (1986).

## 1.3 PROMOTION OF SIMPLIFIED SEWERAGE

This Manual contains a considerable amount of information on simplified sewerage. More is available on the UNDP – World Bank Water and Sanitation Program’s *Sanitation Connection* website.<sup>1</sup> However, even with all this information, how do you set about promoting and implementing simplified sewerage in a country with no previous experience of the technology?

Clearly, the first step is to identify a relatively small poor periurban area in which simplified sewerage appears to be a feasible solution to the community’s sanitation needs.

Secondly, several things need to be done:

- discuss your ideas with senior management of the local sewerage authority,
- contact your local office of the UNDP – World Bank Water and Sanitation Program,<sup>2</sup>
- call a meeting of the community you have identified to present the technology.

If the local sewerage authority has been privatised and the privatisation contract requires the company to achieve 100 percent sanitation or sewerage coverage within (for example) five years, then this is in fact a very good opportunity for the promotion of simplified sewerage since there will generally be no alternative sanitation option that is as financially and technically appropriate as simplified sewerage.<sup>3</sup>

<sup>1</sup> <http://www.sanigate.net> (click on “information by topic”, then on “Low cost Sewerage”)

<sup>2</sup> For addresses (including email addresses), see <http://www.wsp.org> (or email [info@wsp.org](mailto:info@wsp.org)).

<sup>3</sup> See, for example, the El Alto project in La Paz, Bolivia (<http://www.wsp.org/English/urban-elalto.pdf>).

If, on the other hand, the local sewerage authority has not been privatised, then the problem of design standards may arise – national sewerage design codes, which are of course design codes for conventional sewerage, do not generally permit the use of 100 mm diameter sewers laid at a gradient of only 1 in 200.

The way forward here is to present to senior management the fundamentals of simplified sewerage as presented herein, with additional material obtained from the Sanitation Connection website,<sup>4</sup> and show how appropriate simplified sewerage is for the periurban community you have identified, and how – through simplified sewerage (plus, where appropriate, improved water supplies and hygiene education) – the sewerage authority can aid national objectives of overcoming urban poverty (see Alfaro, 1997). The idea is to obtain permission for a small pilot-scale (indeed, experimental) project to evaluate the local feasibility of simplified sewerage (see Section 3). Help will often be available from the UNDP – World Bank Water and Sanitation Program, from agencies such as UNICEF and the European Union, and from bilateral agencies such as DFID,<sup>5</sup> and for technical enquiries from the Sanitation Connection help desk.<sup>6</sup>

Finally, explain the technology to a meeting of the community you have identified (see Figure 1.8).

It will also be a good idea to present your ideas on simplified sewerage at a meeting of your local professional engineers association, and maybe persuade it to establish a Low-cost Sanitation Committee (as was done in Brazil – see Box 1.1). This committee could oversee the pilot-scale simplified sewerage project, and it could then recommend appropriate design standard changes to the national sewerage design code (this was also done in Brazil).



**Figure 1.8.** An engineer from the CAERN R&D Division explaining condominial sewerage to a residents' meeting in Rocas and Santos Reis in Natal, northeast Brazil (*cf.* Box 1.1).

---

<sup>4</sup> Including, for example, the poster on simplified sewerage available at: [http://www.efm.leeds.ac.uk/CIVE/Sewerage/articles/simple\\_pas\\_.pdf](http://www.efm.leeds.ac.uk/CIVE/Sewerage/articles/simple_pas_.pdf)

<sup>5</sup> Contact your local British Embassy or High Commission.

<sup>6</sup> <http://www.sanigate.net/helpdesk> (or email [helpdesk@sanicon.net](mailto:helpdesk@sanicon.net)).

# 2

## Theory of Simplified Sewerage

This Section presents the theory of simplified sewer design. Firstly, in Section 2.1, the peak daily wastewater flow in the length of sewer being designed is described. Section 2.2 presents the trigonometric properties of a circular section, as the sewers used in simplified sewerage are of circular cross-section. The Gauckler-Manning equation for the velocity of flow in a sewer and the corresponding flow equation are given in Section 2.3. Tractive tension is described in Section 2.4, and the minimum sewer gradient based on the design minimum tractive tension is derived in Section 2.5. The procedure for calculating the sewer diameter is given in Section 2.6, and that for determining the maximum number of houses served by a sewer of given diameter in Section 2.7. Finally, the results of a simplified sewer design trial are presented in Section 2.8; this was a comparison of designs based on the Gauckler-Manning, Colebrook-White and Escribano equations (details are given in Appendices 1 and 2). The overall design procedure follows that given in Mara (1996) (see also, Yao, 1974; Machado Neto and Tsutiya, 1985; de Melo, 1985 and 1994; Bakalian *et al.*, 1994).

### 2.1 WASTEWATER FLOW

The value of the wastewater flow used for sewer design is the daily peak flow. This can be estimated as follows:

$$q = k_1 k_2 Pw / 86\,400 \quad (2.1)$$

where  $q$  = daily peak flow, l/s

$k_1$  = peak factor (= daily peak flow divided by average daily flow)

$k_2$  = return factor (= wastewater flow divided by water consumption)

$P$  = population served by length of sewer under consideration

$w$  = average water consumption, litres per person per day

and 86 400 is the number of seconds in a day.

A suitable design value for  $k_1$  for simplified sewerage is 1.8 and  $k_2$  may be taken as 0.85. Thus equation 2.1 becomes:

$$q = 1.8 \times 10^{-5} Pw \quad (2.2)$$

The design values given above for the peak flow factor,  $k_1$  and the return factor,  $k_2$  (1.8 and 0.85 respectively) have been found to be suitable in Brazil, but they may

need changing to suit conditions elsewhere – especially if stormwater (for example, roof drainage water) is discharged into the simplified sewer. However, this should **not** be permitted to occur as the resulting design for what is in practice partially combined sewerage system would be based on a much higher value for  $k_1$  (perhaps as high as 3 or 4), but see Section 2.1.1.

Variations in the value of  $k_2$  have a much lower impact on design, except in middle- and high-income areas where a large proportion of water consumption is used for lawn-watering and car-washing. In periurban areas in Brazil a  $k_2$  value of 0.85 has been used successfully, although CAESB now uses a value of 0.65, even in low-income areas and without any reported operational problems (Luduvic, 2000). However higher values may be more appropriate elsewhere – for example, in areas where the water supply is based on a system of public standpipes, values up to 0.95 may be used.

### 2.1.1 Minimum daily peak flow

In simplified sewer design equation 2.1 or 2.2 is used to calculate the daily peak flow in the length of sewer under consideration, but subject to a minimum value of 1.5 l/s (see Section 2.6). This minimum flow is not justifiable in theory but, as it is approximately equal to the peak flow resulting from flushing a WC, it gives sensible results in practice, and it is the value recommended in the current Brazilian sewer design code (see ABNT, 1986; also Sinnatamby, 1986, although he used a minimum flow of 2.2 l/s).

With the use of this minimum value for the peak daily flow, the values used for  $k_1$  and  $k_2$  in equation 2.1 become less important, especially for short lengths of sewer. For example, for a length of sewer serving 500 people with a water consumption of 80 litres per person per day and using a return factor of 0.85, the average daily wastewater flow is given by equation 2.3 as:

$$\begin{aligned}
 q &= k_2 Pw / 86\,400 && (2.3) \\
 &= 0.85 \times 500 \times 80 / 86\,400 \\
 &= 0.4 \text{ l/s}
 \end{aligned}$$

For the minimum peak daily flow of 1.5 l/s, this is equivalent to a  $k_1$  value of  $(1.5/0.4) = 3.75$ . Thus for condominial sewers serving even quite a large number of people, there is an inherent allowance for at least some stormwater (see Section 3.3.3).

## 2.2 PROPERTIES OF A CIRCULAR SECTION

The flow in simplified sewers is always open channel flow – that is to say, there is always some free space above the flow of wastewater in the sewer. The hydraulic design of simplified sewers requires knowledge of the area of flow and the hydraulic radius. Both these parameters vary with the depth of flow, as shown in Figure 2.1. From this figure, trigonometric relationships can be derived for the following parameters:



- (1) the **area of flow** ( $a$ ), expressed in  $\text{m}^2$ ;
- (2) the **wetted perimeter** ( $p$ ), m;
- (3) the **hydraulic radius** ( $r$ ), m; and
- (4) the **breadth of flow** ( $b$ ), m.

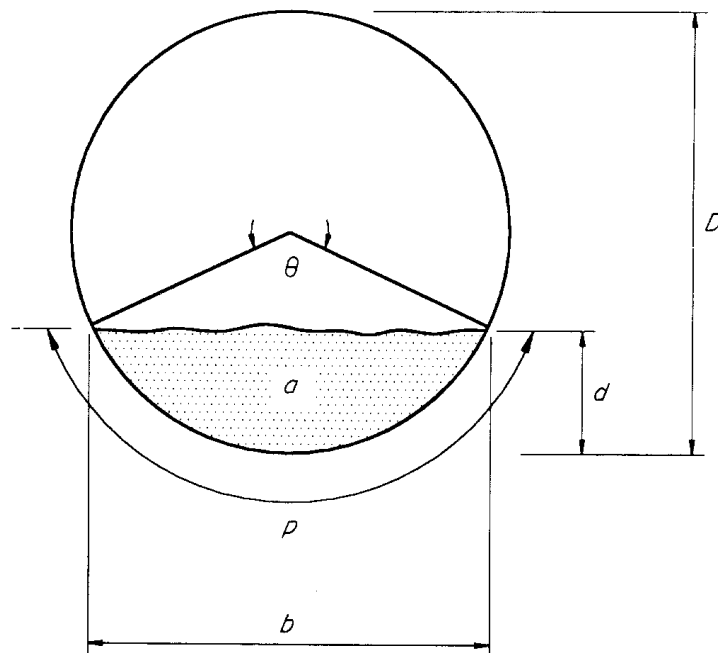
The hydraulic radius (sometimes called the hydraulic mean depth) is the area of flow divided by the wetted perimeter.

The breadth of flow is used for the calculation of the risk of hydrogen sulphide generation (see Appendix 3), and also in Escritt's (1984) definition of hydraulic radius (see Section A1.4 in Appendix 1).

Parameters 1 – 4 above depend on the following three parameters:

- (5) the **angle of flow** ( $\theta$ ), expressed in *radians*;
- (6) the **depth of flow** ( $d$ ), m; and
- (7) the **sewer diameter** ( $D$ ), m.

If the angle of flow is measured in degrees, then it must be converted to radians by multiplying by  $(2\pi/360)$ , since  $360^\circ$  equals  $2\pi$  radians.



**Figure 2.1** Definition of parameters for open channel flow in a circular sewer. Source: Mara (1996).

The ratio  $d/D$  is termed the **proportional depth of flow** (which is dimensionless). In simplified sewerage the usual limits for  $d/D$  are as follows:

$$0.2 < d/D < 0.8$$

The lower limit ensures that there is sufficient velocity of flow to prevent solids deposition in the initial part of the design period, and the upper limit provides for sufficient ventilation at the end of the design period.

The equations are as follows:

(a) **Angle of flow:**

$$\theta = 2 \cos^{-1} [1 - 2 (d/D)] \quad (2.4)$$

(b) **Area of flow:**

$$a = D^2 [(\theta - \sin \theta) / 8] \quad (2.5)$$

(c) **Wetted perimeter:**

$$p = \theta D/2 \quad (2.6)$$

(d) **Hydraulic radius** (=  $a/p$ ):

$$r = (D/4) [1 - ((\sin \theta) / \theta)] \quad (2.7)$$

(e) **Breadth of flow:**

$$b = D \sin (\theta/2) \quad (2.8)$$

When  $d = D$  (that is, when the sewer is flowing just flow), then  $a = A = \pi D^2/4$ ;  $p = P = \pi D$  and  $r = R = D/4$ .

The following equations for  $a$  and  $r$  are used in designing simplified sewers:

$$a = k_a D^2 \quad (2.9)$$

$$r = k_r D \quad (2.10)$$

The coefficients  $k_a$  and  $k_r$  are given from equations 2.5 and 2.6 as:

$$k_a = \frac{1}{8} (\theta - \sin \theta) \quad (2.11)$$

$$k_r = \frac{1}{4} [1 - ((\sin \theta) / \theta)] \quad (2.12)$$

When  $a = A$  and  $r = R$ , then  $k_a = \pi/4$  and  $k_r = 0.25$ .

## 2.3 GAUCKLER-MANNING EQUATION

In 1889 Robert Manning (an Irish civil engineer, 1816-1897) presented his formula relating the velocity of flow in a sewer to the sewer gradient and the hydraulic radius (Manning, 1890). The formula is commonly, but improperly, known as the Manning equation; as pointed out by Williams (1970) and Chanson (1999), it should be known as the Gauckler-Manning equation since Philippe Gauckler (a French civil engineer, 1826-1905) published the same equation 22 years earlier (Gauckler, 1867 and 1868). The Gauckler-Manning equation (see Appendix 1) is:

$$v = (1/n) r^{2/3} i^{1/2} \quad (2.13)$$

where  $v$  = velocity of flow at  $d/D$ , m/s

$n$  = Ganguillet-Kutter roughness coefficient, dimensionless (but see Appendix 1)

$r$  = hydraulic radius at  $d/D$ , m

$i$  = sewer gradient, m/m (i.e. dimensionless)

Since flow = area  $\times$  velocity,

$$q = (1/n) a r^{2/3} i^{1/2} \quad (2.14)$$

where  $q$  = flow in sewer at  $d/D$ , m<sup>3</sup>/s

Using equations 2.9 and 2.10, equation 2.14 becomes:

$$q = (1/n) k_a D^2 (k_r D)^{2/3} i^{1/2} \quad (2.15)$$

The usual design value of the Ganguillet-Kutter roughness coefficient,  $n$  is 0.013. This value is used for any relatively smooth sewer pipe material (concrete, PVC or vitrified clay – but see Appendix 3) as it depends not so much on the roughness of the material itself, but on the roughness of the bacterial slime layer which grows on the sewer wall.

## 2.4 TRACTIVE TENSION

Tractive tension (or boundary shear stress) is the tangential force exerted by the flow of wastewater per unit wetted boundary area. It is denoted by the symbol  $\tau$  (the Greek letter *tau*) and has units of N/m<sup>2</sup> (i.e. Pascals, Pa). As shown in Figure 2.2, and considering a mass of wastewater of length  $l$  m and cross-sectional area  $a$  m<sup>2</sup>, which has a wetted perimeter of  $p$  m, the tractive tension is given by the component of the weight ( $W$ , Newtons) of this mass of wastewater in the direction of flow divided by its corresponding wetted boundary area (i.e. the area in which it is in contact with the sewer =  $p l$ ):

$$\tau = W \sin \phi / p l \quad (2.16)$$

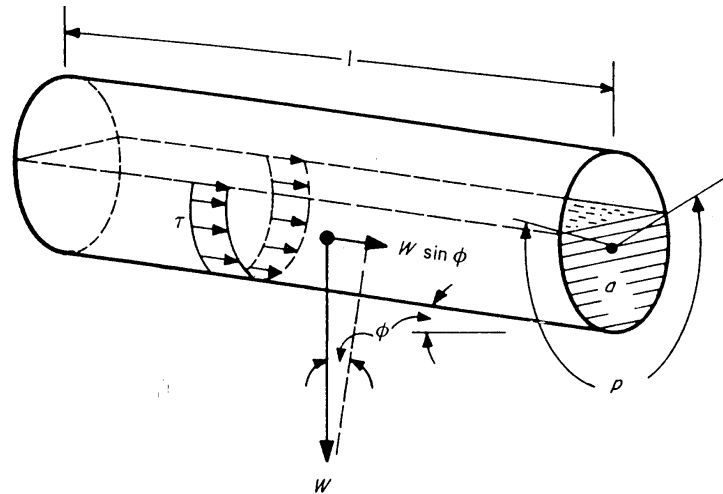
The weight  $W$  is given by:

$$W = \rho g a l \quad (2.17)$$

where  $\rho$  = density of wastewater,  $\text{kg/m}^3$   
 $g$  = acceleration due to gravity,  $\text{m/s}^2$

So that, since  $a/p$  is the hydraulic radius,  $r$ :

$$\tau = \rho g r \sin \phi \quad (2.18)$$



**Figure 2.2** Definition of parameters for tractive tension in a circular sewer. *Source: Barnes et al. (1981).*

When  $\phi$  is small,  $\sin \phi = \tan \phi$ , and  $\tan \phi$  is the sewer gradient,  $i$  (m/m). Thus, equation 2.18 can be rewritten as:

$$\tau = \rho g r i \quad (2.19)$$

Using equation 2.10 and rearranging:

$$D = (\tau / \rho g) / k_r i \quad (2.20)$$

Substituting this expression for  $D$  in equation 2.15 and simplifying:

$$q = (1/n) k_a k_r^{-2} (\tau / \rho g)^{8/3} i^{-13/6} \quad (2.21)$$

## 2.5 MINIMUM SEWER GRADIENT

The minimum sewer gradient,  $l_{\min}$  is given by rearranging equation 2.21 and substituting  $l_{\min}$  for  $i$  and  $\tau_{\min}$  for  $\tau$ , as follows:

$$l_{\min} = [(1/n) k_a k_r^{-2}]^{6/13} [\tau_{\min} / \rho g]^{16/13} q^{-6/13} \quad (2.22)$$

For  $d/D = 0.2$ , the minimum value used in simplified sewerage – that is, from equations 2.4, 2.11 and 2.12, for  $k_a = 0.1118$  and  $k_r = 0.1206$ ; and with  $n = 0.013$ ,  $\rho = 1000 \text{ kg/m}^3$  and  $g = 9.81 \text{ m/s}^2$ , equation 2.22 becomes:

$$I_{\min} = 2.33 \times 10^{-4} (\tau_{\min})^{16/13} q^{-6/13} \quad (2.23)$$

A good design value for  $\tau_{\min}$  in simplified sewerage is 1 Pa; thus:

$$I_{\min} = 2.33 \times 10^{-4} q^{-6/13} \quad (2.24)$$

In this equation the units of  $q$  are  $\text{m}^3/\text{s}$ . Changing them to litres/second gives:

$$I_{\min} = 5.64 \times 10^{-3} q^{-6/13} \quad (2.25)$$

Equations 2.24 and 2.25 are for a value of  $\tau_{\min}$  of 1 Pa. This value has been successfully used in simplified sewerage systems in southern Brazil where the systems are wholly separate – PVC pipes are used and junction boxes (see Section 5.1.5) are either plastic or, if in brick, have their coverslab well mortared on; thus the ingress of stormwater, soil, grit etc. into the sewer is minimal; moreover used toilet paper is commonly not disposed of in the toilet bowl, but into an adjacent bucket for disposal with household garbage. Yao (1974) recommends values of  $\tau_{\min}$  for sanitary sewers of 1-2 Pa, and 3-4 Pa for stormwater or combined sewers. Designers must make an appropriate choice for  $\tau_{\min}$ , and use equation 2.23 for values  $> 1$  Pa. Values of  $\tau_{\min} > 1$  Pa have a large influence on the value of  $I_{\min}$ . For example, for a flow of 1.5 l/s, equation 2.23 gives:

$\tau_{\min}$ (Pa)	$I_{\min}$
1	1 in 213
1.5	1 in 130
2	1 in 91

CAESB, the water and sewerage company of Brasília and the Federal District, uses a  $\tau_{\min}$  of 1 Pa and a minimum value of  $I_{\min}$  of 0.5% (1 in 200). In low-income areas this has not resulted in any significant operational problems (Luduvic, 2000).

## 2.6 SEWER DIAMETER

Equation 2.15 can be rearranged, as follows, writing  $i = I_{\min}$ :

$$D = n^{3/8} k_a^{-3/8} k_r^{-1/4} (q/I_{\min}^{1/2})^{3/8} \quad (2.26)$$

In this equation the units of  $D$  are m, and the units of  $q$  are  $\text{m}^3/\text{s}$ .

The sewer diameter is determined by the following sequence of calculations:

- (1) Calculate using equation 2.2, the initial and final wastewater flows ( $q_i$  and  $q_f$ , respectively, in l/s), which are the flows occurring at the start and end of the

design period. (The increase in flow is due either to an increase in population or an increase in water consumption, or both.)

If the flow so calculated is less than the minimum peak daily flow of 1.5 l/s (see Section 2.1.1), then use in (2) below a value of 1.5 l/s for  $q_i$ .

- (2) Calculate  $I_{\min}$  from equation 2.25 with  $q = q_i$ .
- (3) Calculate  $D$  from equation 2.26 using  $q = q_f$  (in  $\text{m}^3/\text{s}$ ), again subject to a minimum value of  $0.0015 \text{ m}^3/\text{s}$ , for  $d/D = 0.8$  (i.e. for  $k_a = 0.6736$  and  $k_r = 0.3042$  from equations 2.4, 2.11 and 2.12).

In this design procedure, the value of  $q_i$  is used to determine  $I_{\min}$  and the value of  $q_f$  is used to determine  $D$  (Box 1.1).

The diameter so calculated is unlikely to be a commercially available size, and therefore the next larger diameter that is available is chosen (i.e. if  $D = 86 \text{ mm}$ , say, then choose  $100 \text{ mm}$ ).

The **minimum diameter** used in simplified sewerage is  $100 \text{ mm}$  (but see Section 3.3.4).

## 2.7 NUMBER OF HOUSES SERVED

In the detailed design of condominial sewers (Section 3.2.6) it is useful to know the maximum number of houses that can be served by a sewer of given diameter. The procedure for calculating this is shown here – *as an example only* – for a household size of 5, a per caput water consumption of  $100 \text{ l/d}$ , a peak factor of 1.8 and a return factor of 0.85. The peak flow per household ( $q_h$ , l/s) is given by equation 2.2 as:

$$\begin{aligned} q_h &= 1.8 \times 10^{-5} P w \\ &= 1.8 \times 10^{-5} \times 5 \times 100 \\ &= 0.009 \text{ l/s per household.} \end{aligned}$$

If it is assumed that the housing area is fully developed (i.e. that there is no space for further houses), then any increase in wastewater flow will be due to an increase in water consumption.

Designing the sewer for an initial  $d/D$  of 0.6, allows for an increase in water consumption to just under 150 litres per caput per day when  $d/D$  will be the maximum value of 0.8 (see Mara, 1996) – such an increase is more than adequate.

Equations 2.15 (with  $i = I_{\min}$ ) and 2.22 are now solved for  $d/D = 0.6$  (i.e. for  $k_a = 0.4920$  and  $k_r = 0.2776$ ), with  $\tau_{\min} = 1 \text{ Pa}$  and with  $q$  in l/s, as follows:

$$I_{\min} = 0.00518 q^{-6/13} \quad (2.27)$$

$$D = 0.0264 (q/I_{\min}^{1/2})^{3/8} \quad (2.28)$$

Thus, with  $D$  in mm:

$$q = 9.8 \times 10^{-5} D^{13/6} \quad (2.29)$$

The peak flow per household is 0.009 l/s, so that  $q$  is given by:

$$q = 0.009 N \quad (2.30)$$

where  $N$  = number of houses served. Thus:

$$N = 10.89 \times 10^{-3} D^{13/6} \quad (2.31)$$

Equation 2.31 shows that, *for the design values assumed*, a 100 mm diameter sewer can serve up to 234 houses. For any other set of design parameters (including the initial value of  $d/D$ ) an equation corresponding to equation 2.31 has to be derived in the manner shown above.

## 2.8 DESIGN COMPARISONS

In Sections 2.3 – 2.6 the **Gauckler-Manning** equation was used to exemplify the basis of the hydraulic design of simplified sewers. Although it is the only equation to have been used to date for simplified sewer design in practice, there are two other principal equations which are currently used for the hydraulic design of conventional sewers, and which could in principle therefore be used for simplified sewer design. They are:

- (1) the **Colebrook-White** equation (Colebrook, 1938; see also Butler and Pinkerton, 1987 and HR Wallingford and Barr, 1994), and
- (2) the **Escritt** equation (Escritt, 1984).

Appendix 1 presents an overview of the development of the Gauckler-Manning, Colebrook-White and Escritt equations, and Appendix 2 contains the results of comparative trials using these three equations to identify which one is the most suitable overall. These trials comprised comparisons based on the simplified sewer design examples given in Sinnatamby (1986) and Bakalian *et al.* (1994). The results of these trials, show that there is no advantage in using either the Colebrook-White equation or the Escritt equation over the Gauckler-Manning equation. The latter is therefore preferred for use in the PC-based design of simplified sewers detailed in Section 4, although the program allows any of the three to be used.





# 3

---

## The planning and design process

The theory introduced in Section 2 allows a sewer system to be analysed in order that sewer diameters and gradients can be determined. This is only one part of the overall planning and design process. In this section, we set out the steps in this process and explain how the PC-based design program presented in Section 4 fits into this overall process. The section is subdivided as follows:

Section 3.1 is concerned with the initial assessment of sanitation options. The assessment of technical options is explained and the issues relating to the management options for simplified sewerage are explored.

Section 3.2 sets out the sewerage planning process, from the decision to adopt simplified sewerage to the development of the overall sewerage layout. It explains what information is needed for the planning process and explores the factors that will influence the area to be included in a sewerage scheme. This leads in to the development of a draft sewerage plan. In most cases, it will then be necessary to carry out physical and social surveys before finalising sewer routes.

Planning leads into detailed design. Section 3.3 considers various aspects of detailed design, including the selection of design parameters (input parameters, those that over-ride design calculations, and output parameters), and the design of condominial sewers and public collector sewers.

### **3.1 INITIAL ASSESSMENT OF SANITATION OPTIONS**

Two basic questions should be asked at the beginning of the planning process. These are:

- What sanitation options are feasible in the local situation? And
- Assuming that simplified sewerage is feasible, what arrangements are possible for managing the construction and subsequent operation and maintenance of the local condominial systems?

Each of these questions is considered below, and in the case of the first with particular reference to simplified sewerage.

### 3.1.1 Technical options

This is the stage at which the decision to use simplified sewerage will be made. Simplified sewerage should only be considered where a reliable water supply is or can be made available on or near each plot so that total water use is at least 60 litres per person per day. Where this basic criterion cannot be met, other options should be evaluated. Sewers, preceded by settlement tanks and carrying 'settled' wastewater might be considered when water use is lower, perhaps down to 30 litres per person per day. Settled sewerage (also called small-bore, or solids-free, sewerage) is described by Otis and Mara (1985) and in Mara (1996).

Other factors to be considered are population density, the arrangements for effluent disposal and the preferences of the local people; for evaluating on-site sanitation options the plot size, the infiltration capacity of the soil and the potential for groundwater pollution should also be considered (see Franceys *et al.*, 1992; Cotton and Saywell, 1998; and GHK Research and Training, 2000). Figure 1.5 shows that in Natal, northeast Brazil, the household cost of simplified sewerage reduced rapidly up to population densities of around 80 people per hectare. Thereafter, there was a more gradual reduction in cost as the population density increased. Simplified sewerage became cheaper than on-site systems at a population density of around 160 people per hectare. While the precise figures were particular to northeast Brazil at that time, the broad pattern may be expected to occur elsewhere. Simplified sewerage should always be considered as an option when population densities exceed about 150 people per hectare.

When comparing costs between different sanitation technologies, the following points must be taken into account:

- The cost of sewerage is not confined to the cost of local sewers. The cost of any collector and trunk sewers and that of treatment have also to be included.
- Most on-plot sanitation systems do not cater for sullage (i.e. the wastewater from sinks, showers etc.). It may be necessary to include separate drainage facilities for sullage and this cost has to be taken into account in any cost comparison.

Simplified sewerage is more likely to be viable where an existing collector sewer with spare capacity is available reasonably close at hand. The existing sewer represents a sunk cost and the cost of simplified sewerage is therefore reduced.

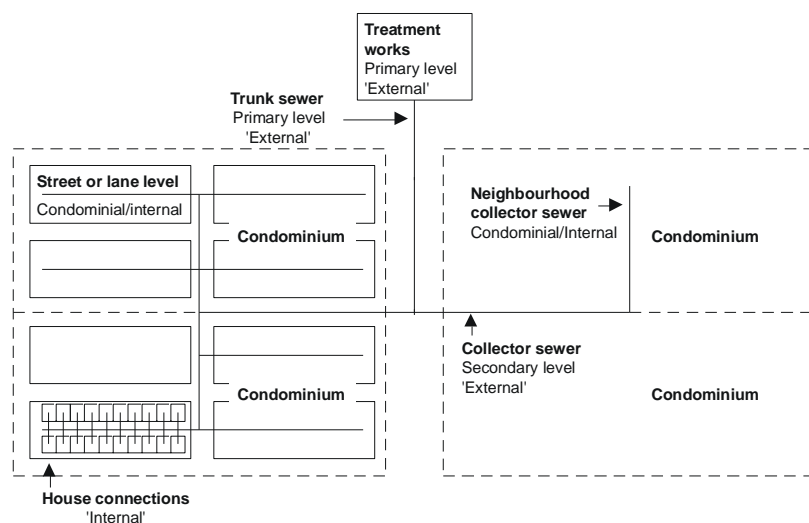
In theory, the cost of sewered sanitation can be reduced by treating wastewater locally, thus removing the need for expensive trunk mains. In practice, lack of both land and the skills necessary to operate local treatment facilities may prevent the adoption of this option.

The operating costs of the various sanitation systems need to be considered when choosing an appropriate technology. For sewerage, the cost of any pumping that may be required must be considered, together with who is going to pay for it. The cost (and availability and reliability) of WC flushing water also needs to be included.

User preferences are likely to influence choice when there is little to choose between two sanitation technologies. In general, users prefer sewers because they remove all wastewater (i.e. both toilet wastewater and sullage) from the house and, if properly constructed, they require relatively little maintenance. In some cases, local people may be opposed to sewers because of previous bad experiences. These normally relate to bad design, bad operation and maintenance, misuse (for instance dumping solid waste in the sewers) or some combination of the three. In such circumstances, the reasons for the previous problems should be ascertained and the ways in which they can be overcome should be discussed with the users.

### 3.1.2 Management options

It is important to consider the possible management options for any proposed sanitation system from the very beginning of the planning process. In general, the more small-scale and local a sanitation system, the better the prospects for local management. So, it would appear that on-plot sanitation systems such as pit latrines and pour-flush toilets discharging to leach pits can be managed by individual householders, while city-wide sewage disposal systems must be managed at the municipal level. In practice, household sanitation facilities, sewers and wastewater disposal facilities together form a hierarchical wastewater disposal system, as shown diagrammatically in Figure 3.1.



**Figure 3.1** Sewerage as a hierarchical system.

In northeast Brazil it was originally assumed that each household should be responsible for the facilities within its plot boundary while all other facilities are managed by an organisation operating at the municipal or even the regional or national level, typically the municipality itself, a specialist sewerage agency or a department of regional or national government (see Section 5.2). Figure 3.1 suggests that a second division is possible, between those system components that serve particular areas or 'condominiums' and those that have a wider city or city district function. A condominium will normally include a number of streets or lanes that can be sewered to one connection with a higher-order collector sewer. The condominial systems do not have to be managed by the same organisation that manages the higher-order facilities and may be suitable for management by a local

organisation, either the local community itself or a contracted private sector organisation (Section 5.2). In the latter case, the contract should ensure that the contractor is responsible to the local community for the performance of the system.

This division of responsibilities can result in better management of local facilities because it ensures that responsibility for the local facilities lies those (the community members) who are directly affected by the performance of these facilities. At the same time, it ensures that organisations such as municipalities, specialist sewerage agencies and government departments can make the best use of their resources by focusing on the operation and maintenance of the higher-order facilities that are not suitable for local management.

This is the thinking behind the condominial approach as originally developed in Brazil. It also underlies the similar division between 'internal' and 'external' facilities developed by the Orangi Pilot Project (OPP) in Pakistan. The OPP philosophy is that users should take full responsibility for providing and managing all internal facilities, while the government should similarly take full responsibility for managing external facilities, including collector and trunk sewers and wastewater treatment facilities. The exact details of the division of responsibilities should be decided in the light of the local situation under consideration.

Local management does not mean that all the tasks associated with operating and maintaining sewers have to be carried out by users themselves. Management options for operation and maintenance are extremely important in ensuring system sustainability; these are considered in Section 5.2.

It is extremely important to evaluate what management arrangements are possible in the local situation. In particular, community management should not be considered an option for a local simplified sewerage schemes connected to a municipal system when the operators of the municipal system do not recognise the right of local users to manage their own system.

## **3.2 PLANNING FOR SEWERAGE**

In this section we describe the steps that lead from the decision to adopt simplified sewerage to the development of a sewer layout that can be analysed using the PC-based sewer design program detailed in Section 4. These steps can be summarised as follows:

- (1) Collect existing information, focusing particularly on maps and plans of the area to be sewered and adjacent areas,
- (2) Determine the area to be included in the sewerage plan, based on topography, the location of existing sewers and the limits of existing and future development,
- (3) Develop a draft sewerage plan, showing the routes of the main collector sewers and the approximate areas of the various condominial systems,

- (4) Undertake additional surveys as required to allow sewer routes and the areas of condominial systems to be confirmed, so that detailed design can be carried out, and
- (5) Finalise the overall sewerage plan and plot the sewer routes at an appropriate scale or scales.

### **3.2.1 Collection of existing information**

The first task in the planning process is to collect all available information on the area to be sewered. In particular, existing topographical maps and any maps showing the routes of existing drains and sewers should be collected, as these are needed to define the area to be sewered and determine the overall sewer layout. This information may be available on a number of maps and plans; if this is the case, as much information as possible should be transferred to one base plan.

Information on existing management arrangements and responsibilities also needs to be collected. This provides a sound basis for developing institutional arrangements to manage the proposed system. One of the advantages of dividing sewerage schemes into condominial and collector systems lies in the possibilities for local management of the former. With this in mind, information on existing community structures and systems should be collected, so that the potential for local management of condominial systems can be assessed.

### **3.2.2 Area to be included**

The next task is to decide the area to be included in the scheme. There are two possible situations. The first is that the design is for an exclusively local system, which can be connected to a local treatment facility or an existing collector sewer. The second is that there is a need to look at the sewerage needs of a wider area, including both local condominial sewers and public collector sewers.

In the first case, the decision on the area to be included in the scheme is relatively straightforward. In general, its boundaries will coincide with those of the existing or planned housing scheme that is to be sewered. The main task will be to determine the routes of the internal condominial sewers and the points at which they will discharge to a treatment site or existing sewer.

The second situation is more complicated in that the boundaries of the area to be drained by the collector sewers may not be immediately obvious. The important point is to ensure that the overall situation is taken into account, as defined by natural drainage areas, the location of existing sewers and possible treatment/disposal locations. The boundaries of natural drainage areas should be fairly obvious in hilly or undulating areas. They may be much less obvious where the topography is flat. Where this is the case, the routes of existing natural watercourses, drains and sewers will give a good idea of existing drainage patterns. By plotting existing drains on a suitable plan (typically at a scale of between 1:2000 and 1:10,000, depending on availability and the area to be sewered), the approximate boundaries of drainage areas and the main drainage paths should be able to be defined. As this 'context plan' is developed, any land that might be

available for local treatment should be identified. This allows the relationship between the scheme area and possible treatment/disposal facilities and sites to be explored. This in turn enables the possible advantages of enlarging the scheme to cover surrounding areas to be assessed.

### **3.2.3 Development of a draft sewerage plan**

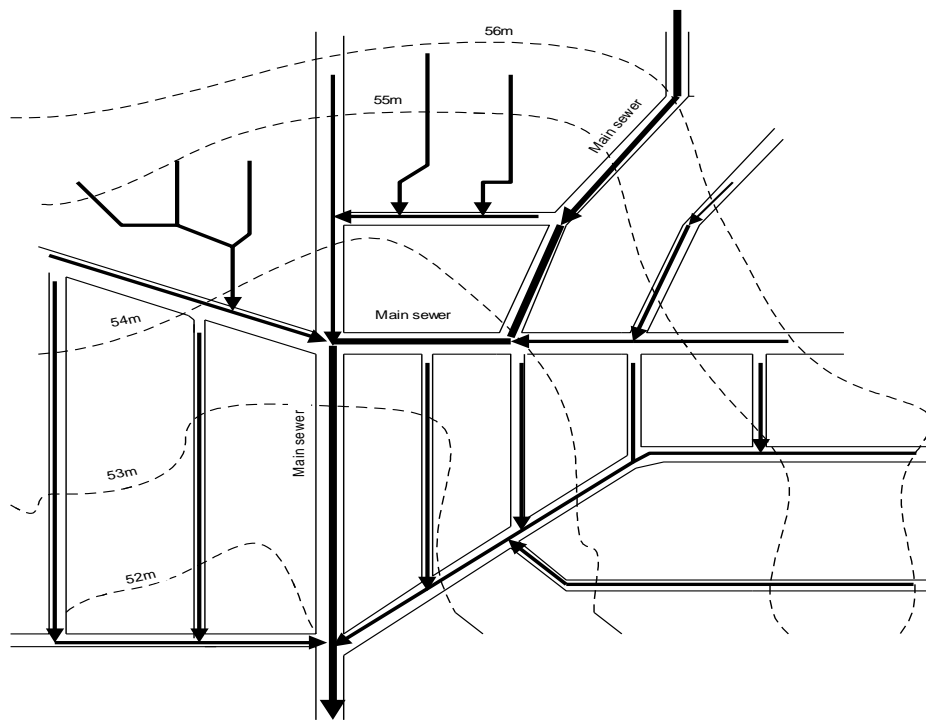
It should now be possible to develop a draft sewerage plan. Whether this covers a local system or the sewerage needs of a wider area, the same basic principles apply. Sewers should be routed as close as possible to natural drainage routes, while taking into account existing land development and ownership patterns. In general, collector sewers should be routed in public rights of way which are close as possible to natural drainage routes. Where an existing drainage channel is located along a narrow right of way between existing houses, the sewer should preferably be rerouted along adjacent roads where there is better access for maintenance.

The first step is to decide the routes of the main public collector sewers and then consider how local condominial systems can be joined to them. In general, public collector sewers should be designed to include flows from all parts of the drainage area that are or are likely to be sewered. Failure to do this will mean that the sewers will be undersized, if not immediately then certainly in the future.

Once the routes of the main public collector sewers are decided, preliminary proposals can be made for the routes of condominial systems. It is possible that as this is done, minor adjustments to the routes of the main sewers may need to be made.

Figure 3.2 shows a possible sewer layout for an area including a single public collector sewer and a number of condominial sewers. Note that the main collector sewer is routed along roads, keeping as close as possible to the natural drainage route that can be determined by the contours. Some of the condominial systems connecting to the main sewer are routed along roads, while those at the top of the figure are assumed to be in-block systems, passing through the private space between houses.

The accuracy with which sewer layouts can be plotted at this stage will depend on the accuracy of the available plans and the availability of information on ground levels. Final decisions on the limits of condominial systems may also be influenced by social factors. The next section considers the steps to be taken to collect and record the physical and social information necessary for detailed design.



**Figure 3.2** Sewer plans should respect the natural topography.

### 3.2.4 Physical and social surveys

If accurate survey information is not available, detailed physical and social surveys are generally required. Each is briefly considered in turn below.

#### ***Physical surveys***

Physical surveys are required in order to determine sewer routes and levels. If existing plans exist, it may be possible to use them, at least for preliminary design. However, checks on their accuracy should always be made, and they must be updated to include any developments that have taken place since they were produced.

Where plans are non-existent or insufficiently detailed, additional surveys will be required to provide information on the overall layout of the area. A full triangulated survey will normally be necessary for larger areas, although there may be the possibility of developing a municipal base-map from satellite imagery or aerial photographs. Plane table survey methods are often used to provide surveys at the condominium level, although a tape survey may provide all the information that is necessary for the design of a small, relatively uncomplicated area.

Context plans showing the overall drainage situation should normally be at a scale of 1:2000 or 1:5000. Smaller-scale plans may be necessary to show the city-wide situation. These should show rights of way, the routes of public collector sewers and the limits of natural drainage areas. They do not need to show individual plots, although it will be useful if they distinguish between built-up and non built-up areas.

Plans for detailed sewer design should normally be at a scale of 1:500 or 1:1000. If sewers are to be routed in public rights of way, the plans should show the frontages of individual plots. (Normally the full plot will be shown but the boundaries between plots do not have to be accurately shown.) Where condominiumal sewers passing *through* plots are envisaged, the survey has to show each building on the plot so that the detailed sewer route can be planned. It may be advisable to use a larger scale, perhaps 1:200 or 1:250, in such cases.

Surveys of the sites proposed for any local wastewater treatment facilities will also be required. The scale will depend on the size and type of facility. A waste stabilisation pond system covering an area of 10 hectares and serving a population of 50,000 to 100,000 might require a survey at a scale of 1:500. The sites for small local treatment facilities will normally require more detailed surveys. For such facilities, the site should be mapped at a scale of 1:100 or 1:200.

Levels are required for detailed sewer design. Where sewers are located in public rights of way, levels should be taken at every intersection and at intervals of perhaps 20–25 metres along roads and access paths. House plinth levels should also be recorded. It is not necessary to record every plinth level; rather the focus should be on the lowest plinths since these will be critical to the sewer design.

Where the possibility of using an in-block system exists, levels will also be required within plots along possible sewer routes. The plinth levels of existing sanitation facilities, particularly those located at the back of plots, may also have to be recorded.

### ***Social surveys***

Simple social surveys should be used to provide information on household sizes and incomes, existing sanitation and water supply facilities, attitudes to sanitation and user preferences. Questionnaire surveys are useful for providing quantitative information. Semi-structured interviews and focused group discussions are more likely to provide information on attitudes and preferences.

The options for management can be explored in community meetings, although it will be wise to back these up with smaller meetings with particular groups. This is because minority viewpoints may not emerge in open community meetings.

It will be particularly important to explore the degree of cooperation present within the community when in-block sewers are being considered. This is because the sewers pass through private property and it will be necessary to negotiate agreements on access for routine maintenance and dealing with blockages and other problems. Ideally, there should be some form of written agreement between the households concerned regarding access to the sewer. Where this is not



possible, there should at the very least be a strong verbal agreement, agreed in a community meeting and backed by the leaders of the community. If surveys reveal uncertainty about the degree of cohesion present within the community, it will probably be wiser to route sewers in public rights of way.

### **3.2.5 Final sewer routes**

Once good survey information has been obtained, it can be recorded on suitable plans and detailed design of the system can commence. Minor changes to the routes of collector sewers may be required as a result of improved survey information. More substantive changes may be necessary in condominiumal systems as a result of the findings of both the physical and social surveys.

The preferred options for condominiumal sewers should be decided in consultation with local people, bearing in mind the management arrangements to be adopted. (Statutory providers are much less likely to agree to route sewers through private land than community management groups.)

## **3.3 DETAILED DESIGN**

### **3.3.1 Introduction to the design process**

Detailed design requires a combination of hydraulic calculations and the application of standard designs, procedures and details. In some cases, for instance the minimum allowable sewer diameter, the application of a design standard may override the results of design calculations.

Sections 3.3.2 to 3.3.5 are concerned with design parameters. The way in which they can be categorised is explained first in Section 3.3.2, and then input parameters, parameters that over-ride design calculations and output parameters are discussed in Sections 3.3.3 – 3.3.5.

Attention then turns to the design calculations. It is possible to carry out these for sewer systems as a whole. Alternatively, it is possible to design individual condominiumal systems first and then to input some of the data from these calculations into the calculations for the design of public collector sewers. The most appropriate approach will depend on the designer's preferences and the local situation. The design of a local condominiumal system is considered first in Section 3.3.6, and the design of public collector systems in Section 3.3.7.

### **3.3.2 Categories of design parameter**

Design parameters include those that are required for calculation purposes and those that over-ride design calculations. The former include the average household size, the average per caput water consumption, the return factor and the various factors that affect the total design flow. These are introduced in Section 3.3.3. Parameters that over-ride design calculations are the minimum sewer diameter and the minimum design flow, and these are considered in Section 3.3.4. There is only

one design output parameter and this is the minimum sewer gradient which is considered in Section 3.3.5.

There is a further category of design parameters which emerge from investigations of field conditions. These include the type of access allowable, the manhole/chamber spacing and the minimum allowable chamber dimensions, and these are considered in Section 5.

### 3.3.3 Design input parameters

**Average household size.** This is multiplied by the number of houses in an area or along a sewer leg to determine the design population in that area or contributing to the sewer leg. Results from the social survey (Section 3.2.4) will provide information on the average household size in the area to be sewered.

**Average per caput water consumption.** This is multiplied by the design population for any area or sewer leg to calculate the total amount of water used during a typical day. Information on average per caput water consumption may be available from meter readings. Failing this, the local water authority may keep records of average per caput consumption in different areas and types of development. The likely per caput water consumption at both the beginning and the end of the design period (which will typically be 30 years) has to be considered.

**Return factor.** This defines the percentage of total water consumption that will be discharged to the sewer. It is often assumed to be 80% or 85%, although there are indications that lower return factors may be appropriate in some areas (see Section 2.1). The wastewater flow from an area will be equal to the water consumption in the area multiplied by the return factor.

**Peak wastewater flow factor.** This is required to allow for the fact that the wastewater flow varies through the day, reaching a peak when people get up in the morning and falling to almost nothing during the night. The peak *foul* flow in any sewer can be taken as the average flow in that sewer multiplied by the peak factor. Peak factors tend to decrease as the population contributing to the flow increases. However, even for a population of a few hundred, the peak factor is unlikely to exceed 2 (see Section 2.1.1). (Higher peak factors might occur in areas where the water supply is intermittent and households have made little or no provision for water storage, but these conditions are unlikely to be suitable for sewerage in any case.)

**Groundwater infiltration.** This needs to be considered where some sewers are laid below the groundwater table. Infiltration is commonly estimated on the basis that it is a set percentage of the average per-caput wastewater flow. A theoretically more accurate approach will be to assume an infiltration rate per unit length of sewer. The first method is simpler. Furthermore the accuracy of available information will normally be insufficient to justify the adoption of the second approach. However, laying sewers below the groundwater table should be avoided wherever possible.

**Allowance for stormwater.** Sewers can be designed as separate, partially combined or combined. Separate sewers carry only wastewater, partially combined

sewers are designed to carry some stormwater in addition to wastewater, while combined sewers are designed to carry the full wastewater and stormwater flows.

Combined sewerage has several disadvantages. In all but the driest climates, the size of sewer required to carry the full stormwater run-off is likely to be much larger than that required for the wastewater flow. Combined sewerage thus requires a high level of investment, which is not utilised except in wet weather. Combined sewers also have the disadvantage that stormwater run-off often carries a high concentration of grit and other suspended solids and this can lead to higher rates of silting. Sewers have therefore to be laid at greater gradients than would be required if they carried only wastewater. For these reasons, simplified sewer systems should not be designed as combined.

Normal practice in many industrialised countries is to provide nominally separate wastewater and stormwater systems. However, in practice, it is extremely difficult to exclude all storm flows and so separate systems are always designed with some allowance for the entry of storm flows. As already indicated, the peak wastewater flow will not exceed twice the average dry weather wastewater flow. Despite this, sewers in the United Kingdom are normally designed for a peak flow of six times the average dry weather flow plus any allowance for industrial flows and groundwater infiltration. In effect, the sewers are designed on the assumption that they may be expected to carry a peak storm flow equivalent to about twice the peak wastewater flow.

The situation in low-income periurban settlements in developing countries is unlikely to be different. Even if householders are educated about the problems that are likely to be caused if stormwater run-off is introduced into sewers, some will still connect their yard or roof water into the sewer. For example, in low-income areas in Brasília and Natal around a quarter of households discharge some stormwater into their simplified sewer (Sarmientos, 2000), despite the fact that CAESB and CAERN officially ban this practice. In other cases, people will take the path of least resistance when faced with the possibility of flooding. For instance, it is not uncommon for people in Pakistan to lift manhole covers to allow water to run away into the sewers during and after storms.

So, it would appear to be unrealistic to design simplified sewerage systems to be completely separate. However, as explained in Section 2.1.1, there is some “automatic” provision for stormwater flows in short lengths of simplified (i.e. condominial) sewer. For public collector sewers some provision for stormwater flows should be made at the design stage (see Section 4.7.3). Where surface water drainage is a major problem, greater attention to the alternatives will have to be paid at the design stage; for more detailed information on planning for stormwater drainage, reference should be made to Kolsky (1998).

**Minimum cover.** Cover is required over a sewer for three reasons:

- (1) To provide protection against imposed loads, particularly vehicle loads,
- (2) To allow an adequate fall on house connections, and
- (3) To reduce the possibility of cross-contamination of water mains by making sure that, wherever possible, sewers are located below water mains.

Simplified sewerage should be designed with the objective of minimising cover by locating sewers away from heavy traffic loads and as close as possible to existing sanitary facilities. In most cases, the loading criterion will be more critical than that to ensure adequate falls on house connections. The minimum cover criteria adopted will depend on local factors, in particular on the pipe material used. In northeast Lahore, Pakistan 230 mm diameter reinforced concrete sewers were laid successfully in lanes with minimal traffic loading at covers of only around 250 mm. In Britain, good quality clay pipes can be laid through gardens at a depth of 350 mm. In Brazil a minimum cover of 200 mm is used for in-block clay or uPVC sewers, and 400 mm for in-pavement sewers (Sinnatamby, 1986; see Section 5.1.2).

The need to prevent cross-contamination of water mains also has to be considered. In northeast Lahore, the issue was avoided because galvanised steel pipes, laid above ground on brick-tile ledges along the edges of lanes, were used. This solution is not applicable in all situations and in most cases water mains should be buried. The cover over water pipes can be reduced by laying them, like sewers, away from heavily trafficked areas whenever possible. Another possibility is to use small diameter polyethylene or uPVC pipes (typically with diameters of 50mm or 63 mm rather than 100mm) for tertiary distribution. These can be laid at relatively shallow depths. Wherever possible, water mains and sewers should also be separated horizontally.

### 3.3.4 Design over-riding parameters

**Minimum sewer diameter.** It is necessary to specify a minimum sewer diameter because sewers transport wastewater which contains gross solids. As indicated in Section 2, there is no theoretical reason why the minimum sewer diameter should not be 100mm. However, statutory authorities tend to be conservative on this point: for example, the minimum acceptable sewer diameter in Cairo, Egypt, is 180 mm, while that in Pakistan is 230 mm. Engineers are often reluctant to change. Every effort should be made to introduce appropriate standards, but it may be necessary to accept a higher minimum diameter than is absolutely necessary. In such circumstances, it is best to seek what is possible rather than the ideal. For instance, the acceptance of a 150 mm minimum diameter would be a big step forward in Pakistan.

**Minimum flow.** Conventional sewer calculations assume steady-state conditions. In practice, the flow in sewers at the upper end of the system is highly transient. The amount of flow at any time depends on the number of taps running to waste and WCs being flushed. By far the largest flows occur when a WC is flushed. A wave passes down the house connection and into the sewer, becoming attenuated all the time by the effects of friction. Of course, the attenuation will tend to be greater if there is any interruption to its smooth flow – for instance, where a house connection enters a connection chamber above the sewer invert so that flows from the connection have to drop into the main sewer. The current practice in Brazil is to assume a minimum flow of 1.5 litres per second for the wave created by a flushed toilet (see Section 2.1.1).

### 3.3.5 Design output parameter – minimum sewer gradient

There is still considerable uncertainty about the factors that influence solids deposition and movement in sewers. Research suggests sewers laid at flat gradients can remain free of settled solids even at very flat gradients. An example is provided by Gidley (1987), who reports on 6 and 8 inch (150 and 200 mm) diameter sewers laid at gradients of 0.11 and 0.2 percent (i.e. 1 in 900 and 1 in 500) in Ericson, Nebraska. The scheme served 80 households, a school and several commercial establishments; no operational problems occurred during 1976-1987, and there was no special maintenance. Lillywhite and Webster (1979) investigated the operation of a hospital drainage system in the United Kingdom, much of which had been laid to very flat gradients. They found that blockages rarely occurred except at points where there were faults in construction (for example, badly aligned sewer pipes) that broke the smooth flow in the sewer. Their conclusion was that poor construction quality is likely to have a bigger effect on the performance of a sewer than its gradient.

Both these systems can be assumed to have been essentially separate with no possibility of the entry of stormwater. Ackers *et al.* (1996) found that steeper gradients were necessary to avoid siltation in combined sewers receiving occasional high-sediment loads associated with stormwater flows.

What do these findings suggest for the design of simplified sewerage systems? The first point is that the minimum permissible sewer gradient should be related to the construction quality – the better the quality, the flatter the allowable gradient. The second is that flatter slopes will be possible if stormwater, and the silt loading associated with it, can be excluded from sewers or trapped in a gully before entering the sewer (see Section 5.1.3).

Methods for calculating the minimum sewer gradient were introduced in Section 2.5. The key parameter in determining the theoretical minimum gradient is the value adopted for minimum tractive tension. If the sewer can be constructed to a high standard and most stormwater can be excluded from the sewer, a value of 1 Pa can be used. This will give a minimum self-cleansing gradient of 1 in 213. As noted in Section 2.5, CAESB uses a minimum value of 1 in 200, and this has been found satisfactory for condominial PVC sewers in low-income areas. For public collector sewers designed as partially combined sewers with some provision for the ingress of silt a minimum tractive tension of 1.5 Pa may be more appropriate; the corresponding minimum sewer gradient is 1 in 130. This higher value for minimum tractive tension may also be appropriate when there are doubts about the standard of construction, perhaps because only locally made sewer pipes of varying quality are available.

In situations where in practice it is considered that a minimum gradient of 1 in 200 is difficult to achieve, especially in flat areas if pumping is to be avoided, the designer is faced with two options:

- (1) Accept that some siltation will occur and design the sewer on the assumption (which needs, of course, to be translated into a practical O&M requirement) that it will have to be regularly desilted; or

- (2) Provide interceptor tanks on all house connections to remove all but the smallest and lightest solids, i.e. design the system as a settled sewerage system (Otis and Mara, 1985; Mara, 1996). This allows much lower gradients to be used, but the system will eventually fail if the interceptor tanks are not desludged at the correct frequency.

### **3.3.6 Design of condominium sewers**

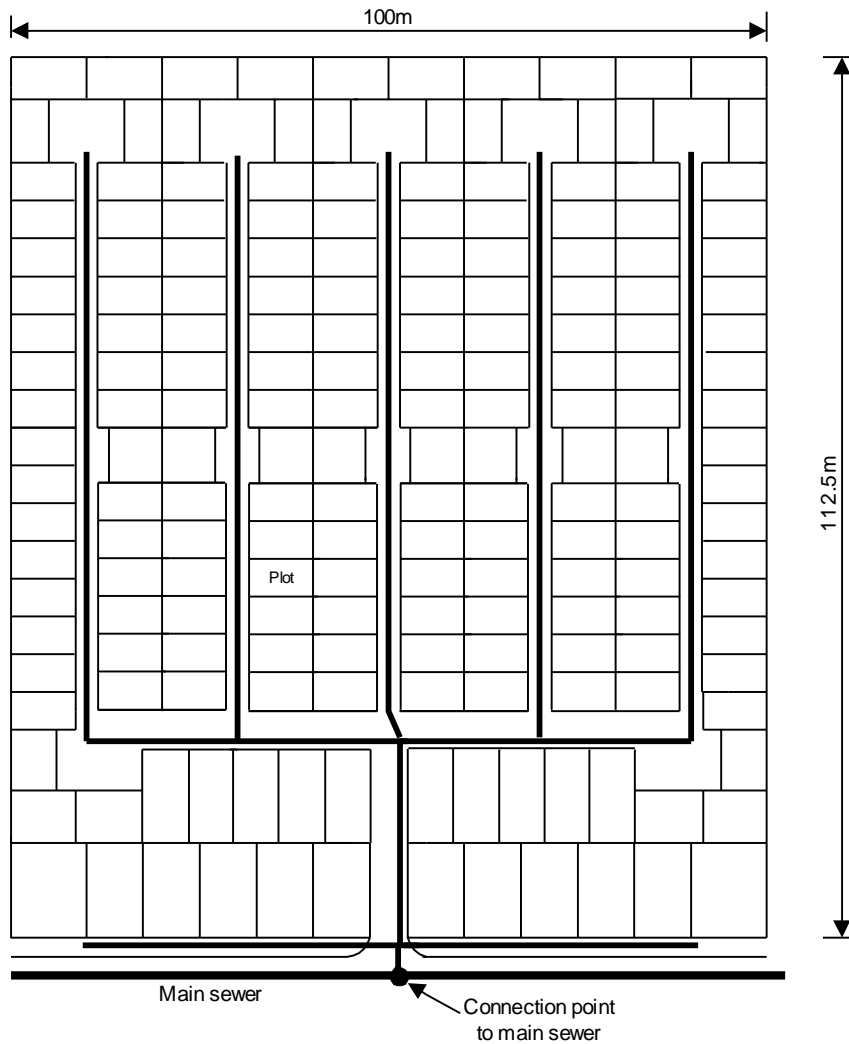
This section details the steps necessary to prepare design information for a condominium sewer system to be input into the design program detailed in Section 4. It uses the example of a module forming part of a new sites-and-services housing scheme.

Figure 3.3 shows this module, together with a sewer layout to serve it. Plot boundaries are represented by thin lines and sewers by thick lines. No access points are shown at this stage. The plot sizes are small, representing typical practice in a new sites-and-services scheme in South Asia. The five cul-de-sacs are relatively narrow lanes that are not intended for vehicular traffic. (The width of the right of way scales about 7.5 metres on the drawing but it can be assumed that the actual right of way is somewhat narrower.) Sewers are proposed along the centres of these pedestrian lanes. Elsewhere inside the module, sewers are alongside the sides of streets, as close as possible to the front plot lines. The housing module fronts onto a main street, along which runs a public collector sewer. The larger plots that face onto the main street are connected to a local sewer that runs under the pavement, rather than directly to the collector sewer.

All the sewers serving the housing module thus form a condominium system that is self-contained and can be analysed and designed regardless of the arrangements that are made elsewhere.

Similar arrangements, but including back-yard and/or front-yard sewers, could be adopted for a scheme with considerably larger plot sizes.

This is, of course, a very regular layout. In practice, many layouts will be less regular with some interconnections between different housing areas so that the limits of each 'condominium' may be more difficult to define. Nevertheless, the basic approach described here is valid for these more complex situations.



**Figure 3.3** Sewer layout for a typical sites-and-services housing module.

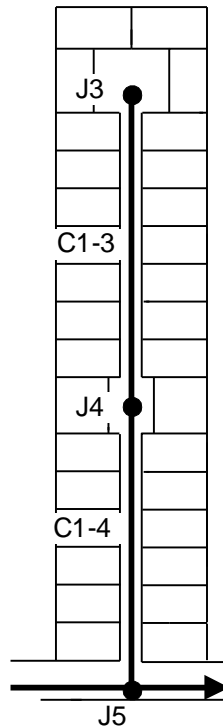
The first step in the design process is to represent the system as a series of sewer ‘legs’ running between junctions or ‘nodes’. In theory every house connection could be a node, but this would require a large number of calculations. The actual calculations are not a problem for the PC-based design program detailed in Section 4, but data entry would take a considerable amount of time. Fortunately such a detailed approach is not necessary since the change in flow at each house connection will be infinitesimally small. Rather, the need is to develop a ‘model’ of the system that reduces the amount of calculation effort required, while retaining sufficient accuracy to ensure that the sewers are correctly sized.

Figure 3.4 illustrates this process of simplification for part of the layout shown in Figure 3.3. Three nodes have been assumed on the sewer that runs along one of the five pedestrian ‘lanes’.

Inspection suggests that the four plots at the head of the lane will drain to a chamber at node J3. Fourteen plots will discharge to sewer leg C1-3 and a further two plots can be connected directly at node J4. Twelve plots will discharge to sewer leg C1-4. For calculation purposes, the number of connections to any sewer leg can be taken as the connections at the upstream node plus those along the length of the sewer

leg itself. Thus, the number of connections to sewer legs C1-3 and C1-4 will be 18 (4+14) and 14 (2+12), respectively.

This process should be repeated for the whole system. The result is shown in Figure 3.5.



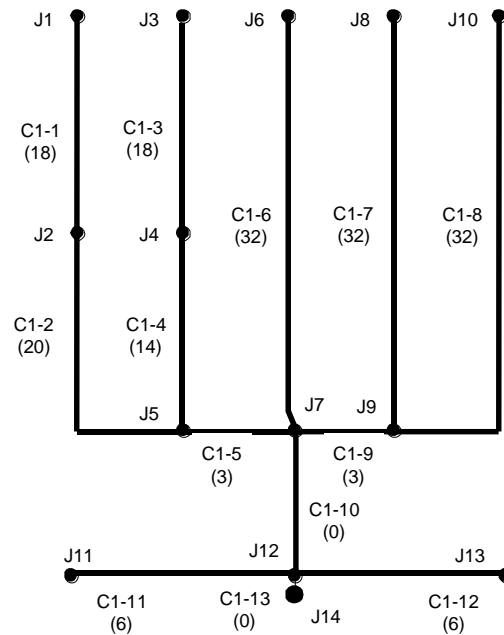
**Figure 3.4** Sewer divided into legs running between nodes.

The PC-based design program will work whatever the numbering system, but interpretation of the results will be easier if there is some logic to the numbering system. With this in mind, the nodes and sewer legs have been numbered starting from the head of the left hand sewer.

The numbering system used for the sewers indicates that a condominium system, rather than public collector sewers, is being designed.

The figures given in brackets beneath the sewer leg numbers in Figure 3.5 are the number of house connections along those legs of the sewer.





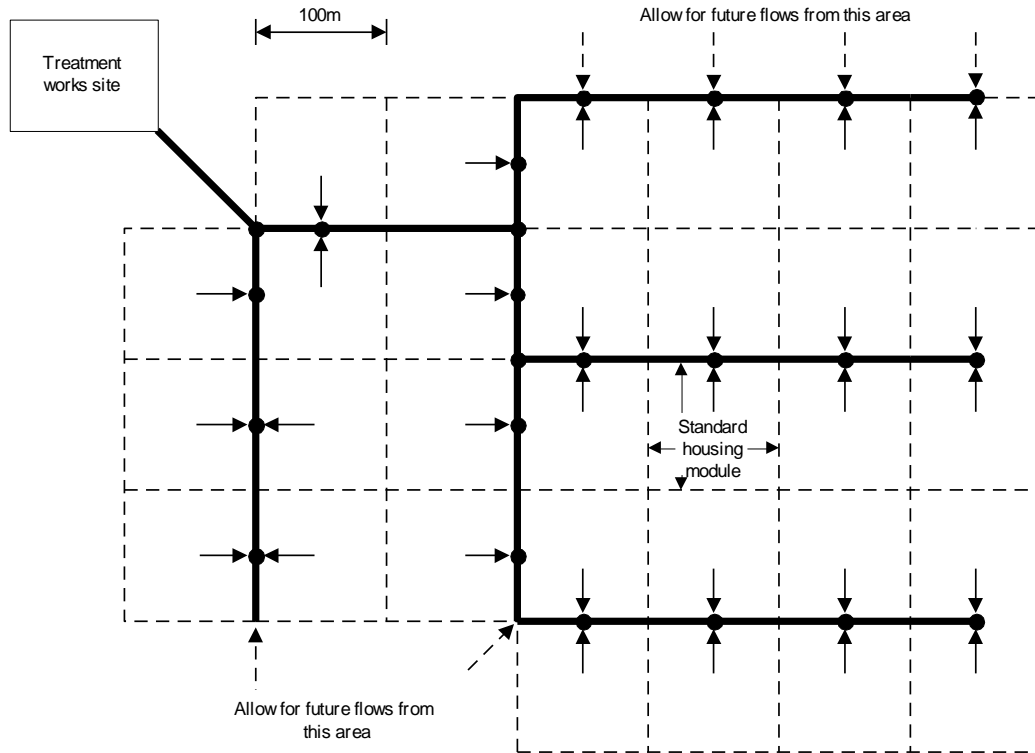
**Figure 3.5** Numbering system for sewer legs and nodes.

Note that the two lane sewers on the left of Figure 3.5 have intermediate nodes, which are omitted from the other three nodes. This has been done in order to test the sensitivity of the model to the number of nodes assumed. In practice, the intermediate nodes are not really required if the average ground slope along the sewers is fairly constant. Additional nodes should be inserted where there is a significant change in ground gradient since the sewer slope will have to be changed at this point and this needs to be reflected in the calculations.

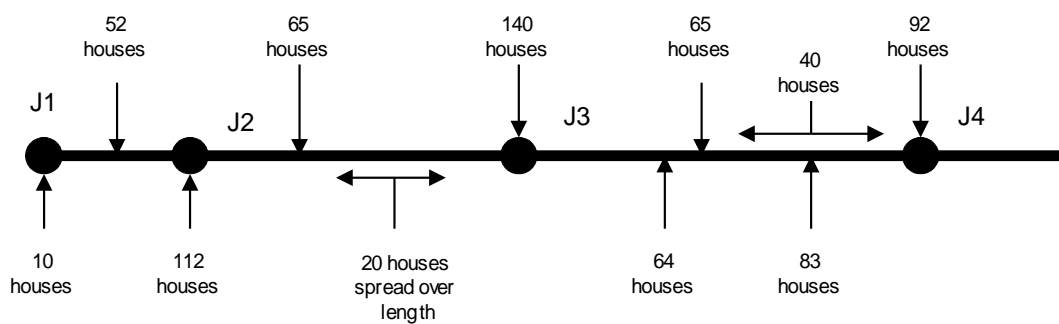
At this point there is much of the information required to input the sewer system into the PC-based design program. Additional information on the sewers themselves is required as follows:

- (1) The lengths of all sewers – obtained by scaling off from the layout drawing.
- (2) The ground level at each node – this is available from the physical survey of the area.
- (3) The minimum allowable cover for different situations – see Sections 3.3.3 and 5.1.2.

The normal procedure will then be to start at the head of the system, in the case illustrated in Figure 3.5 at J1 or J10, and set the sewer invert at that point such that the cover is the minimum allowable for the particular situation.



**Figure 3.6** Layout for public collector sewers for a sites-and-services housing scheme.



**Figure 3.7** Selection of node location.

As the design proceeds, it will be found that the slope of many sewers near the head of the system will be governed by the minimum wastewater flow (1.5 l/s), while their diameter is governed by the minimum permissible sewer diameter (100 mm). The number of houses that can be connected to a standard minimum-diameter sewer laid at the minimum gradient based on the minimum peak wastewater flow can be calculated (see Section 2.7). Once this has been done, these minimum parameters can be assumed for any sewer leg that receives flow from a smaller number of houses than the number calculated for the minimum diameter and gradient. This reduces the design task considerably since many smaller condominiumal systems will consist of only minimum-diameter sewers laid at the minimum gradient based on the minimum peak wastewater flow.

### **3.3.7 Design of public collector systems**

The design approach for public collector systems is essentially the same as that used for condominiumal systems in that, for calculation purposes, the sewer system is divided into legs connected at nodes. Figure 3.6 illustrates a sewer layout for a sites-and-services scheme based on the module that has already been used to illustrate the design of a condominiumal system. The dashed lines indicate the borders of individual housing modules and the thick black lines represent the public collector sewers. The arrows indicate the points at which flows from the various modules are discharged to the public collector sewers. Arrows on dashed lines indicate possible future flows to be considered in the design. The black circles indicate the positions of nodes. It will be seen that a node is located at each junction on the collector sewer system and at the points where flows from the modules discharge to the collector sewers. Any direct inflows to the collector sewer between nodes are assumed to be concentrated at the downstream node, as in the case of condominiumal systems.

This is a regular layout with inflows to the public collector sewers concentrated at nodes. In practice, most systems are more complex and it may be that inflows are spread along the length of the collector sewer rather than concentrated at one point, as shown in Figure 3.7. In such situations, it is necessary to use judgement in the selection of node locations. Figure 3.7 suggests that:

- nodes should be located at all points where there are relatively large inflows to the sewer; and
- closer node spacing is needed near the head of the system.



# 4

---

## PC-based Simplified Sewer Design

### 4.1 OVERVIEW

This Section describes the Windows-based simplified sewerage design program contained on the CDROM supplied with this Manual. The purpose of the program is to aid the design of simplified sewerage systems. It seeks to do this by:

- (1) automating – and thus speeding up – the necessary design calculations;
- (2) providing a tool for analysing different design permutations / configurations; and
- (3) being suitable for training / learning purposes.

The program should only be used by engineers who are “computer-literate.” It is not really suitable for use by others.

#### 4.1.1 System requirements

The program will run on any of the following Microsoft Windows-based operating systems:

Windows 95
Windows 98
Windows 2000
Windows NT4

It will **not** run on computers running the Windows 3.1 operating system.

The monitor screen resolution must be 800 x 600 pixels or greater (this is a very common resolution – only one step up from the minimum possible).

The hardware requirements are not demanding – any PC capable of running one of the above versions of Windows should be able to run this program.

#### 4.1.2 Obtaining the program

If the CDROM is missing from this copy of the Manual, there is an Internet website from where the program can be downloaded; its address (URL) (which is case-sensitive) is:

<http://www.efm.leeds.ac.uk/CIVE/Sewerage>

From this site you can obtain the most up-to-date version of, and latest information on, the program.

### 4.1.3 The definition of a sewer network used in the program

The program requires the sewer network to be described as a series of linked sewer pipes. The sewers may only be linked in a *tree* type manner – that is, the network expands from the most downstream point branching at junctions to several upstream ends. And there must be no loops in the network. (The program has built-in automatic checks which show warnings if any network is entered that cannot be calculated.)

To cater for designing individual sections of a sewer network (which may be drawn together at the end of the design process), the network may be split into sub-networks, termed *sub-nets* in the program. Sub-nets may join other sub-nets at “drop” junctions – i.e. those at which the sewers are not necessarily at the same level. The typical case would be for a small branch sewer sub-network to be designed. When complete, this needs to be linked into a main street/collector sewer that may be at a much lower level.

In summary:

- A **network** consists of one or more **sub-nets** which may join at drop junctions.
- A **sub-net** is a tree structure of sewers whose ends join at continuous levels, i.e. without drop junctions.

In general sub-nets correspond to condominiumal systems as detailed in Section 3.3.6, and these then form the input into public collector sewers as described in Section 3.3.7.

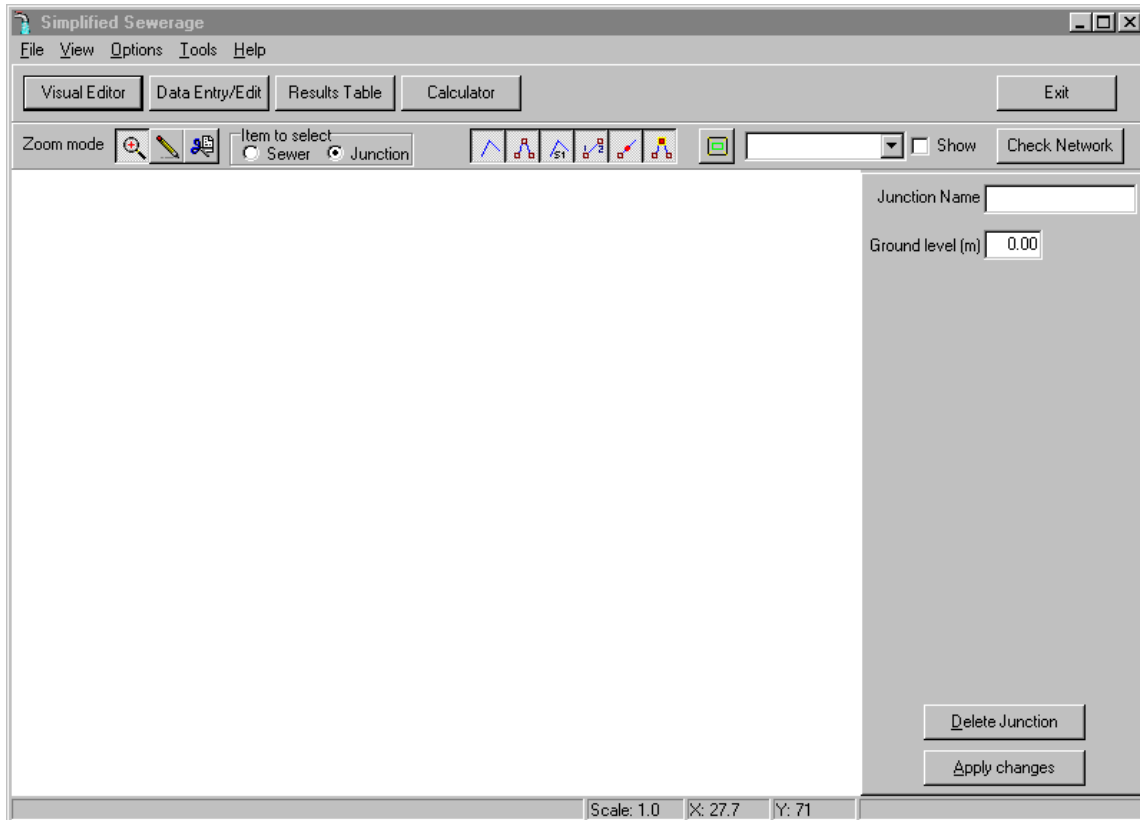
### 4.1.4 The minimum information necessary to use the program

As a minimum to get your basic layout entered, you will need the length of the sewer and number of people connected to it (this may be described in terms of the number of houses connected together with a mean number of people per house, or in terms of a single total number of people who live in houses connected to the sewer). To be of practical use you will also need the ground levels at the end of each sewer length.

### 4.1.5 Getting started

If you really want to jump straight into a design, you can go directly to Section 4.7, where four step-by-step examples are presented. The next sections describe in detail the various screens contained within the program.

On first starting the program you are presented with the screen shown in Figure 4.1.



**Figure 4.1** The Initial screen.

Below the main menu bar are four buttons (Figure 4.2) which allow you to switch between the four main screens of the program:



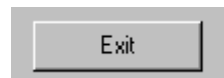
**Figure 4.2** The main Tool Button bar.

The first button takes you to the **Visual Editor** screen. This is the screen that is shown when you first start the program – see Figure 4.1. Here you can draw the sewer network on-screen and also edit all the network description parameters. It provides the normal means of entering all the necessary design data. Section 4.2 contains a detailed description of this screen. An alternative to this method of entering data is by using the **Data Entry/Edit** screen – see below. You may use either or both of these screens to edit your network data.

The second button switches to the **Data Entry/Edit** screen. This is the alternative, table-based method for editing the sewer network description. It is described in detail in Section 4.3.

The third button takes you to the **Results Table** screen – a table of the detailed design results for the sewer network. Here you may also change some of the design calculations and recalculate to show these changes. Section 4.4 contains a detailed description of this screen.

The fourth button displays the **Calculator** screen. On this screen you can see the details of calculations performed for each sewer in the network and adjust the parameters to examine possible design changes. This screen is fully described in Section 4.5.

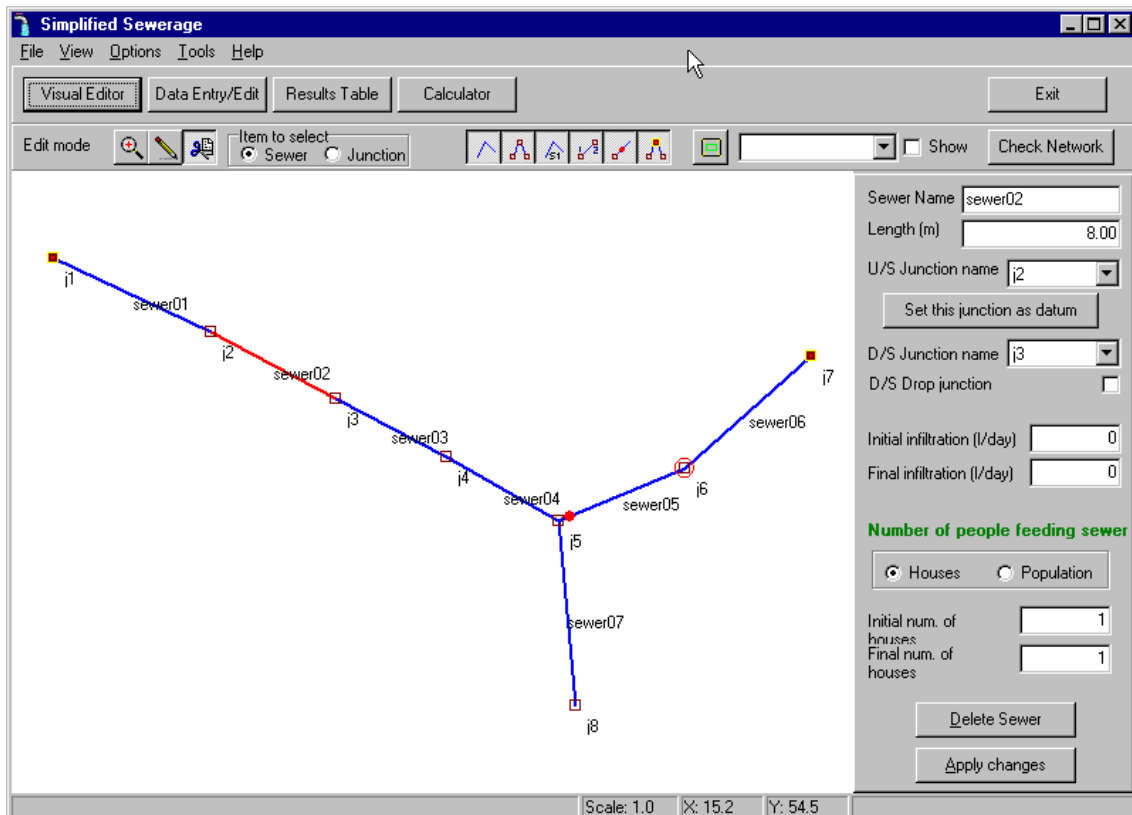


**Figure 4.3** Exit button.

There is a fifth button on this toolbar – the **Exit** button (Figure 4.3), to allow you to leave the program. You will be prompted for confirmation to prevent accidental closure of the program or closure before first saving your edited network.

## 4.2 VISUAL EDITOR SCREEN

This screen (Figure 4.4) allows you to draw the sewer network on-screen and also edit all the network description parameters. This screen should be used as the main set-up screen for any network that you wish to develop, following the procedure given in Section 3.3.6. From this screen all network changes can be made. An alternative method of changing/specifying the network is provided using the **Data Entry/Edit** screen (Section 4.3) where all changes are made by entries in tables and boxes. Changes made on one screen are automatically changed on the other.



**Figure 4.4** Visual Editor screen.



Note that this screen does **not** draw the network to scale. Lengths drawn on the screen do **not** necessarily represent the actual length on the ground, or the actual length entered in the data; thus changing the data values in the program will not change the view on the screen. The reason for this is that simplified sewerage is designed without requiring a detailed survey of positions of sewer ends (only levels are required); hence the co-ordinates of sewer ends are not usually known. It would, of course, make sense to draw any network on the screen to look *similar* to that being designed on the ground.

There are three main parts to this screen: the toolbar (Figure 4.5), which allows setting of the editing and display options for the network.



**Figure 4.5** Visual Edit toolbar.

The details panel to the right provide the means for giving, and allowing changes to, details of either the selected sewer or junction (see Figures 4.12 and 4.15)

The initially blank white panel (Figure 4.1) is where the network will be displayed and the status bar at the bottom (Figure 4.6) displays such information as scale factor, and the mouse co-ordinates.



**Figure 4.6** Status bar.

On starting the program this screen shows a blank white panel (Figure 4.1). You have two options at this point:

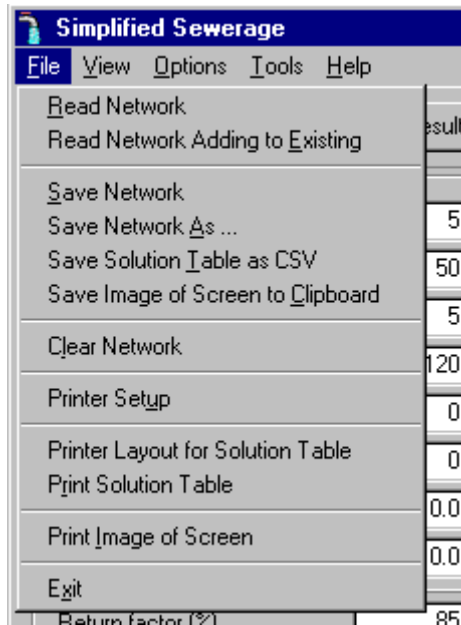
- (1) To read in an existing network, or
- (2) To start drawing your sewers on the white panel.

### **1. To read an existing file:**

An existing network can be read from the main menu by choosing the File/Read Network option (Figure 4.7).

You will be prompted to choose a sewer network file. These files have the extension “.snt” and all existing network files will be displayed in the open file dialog box. Several network files are supplied with the program in the directory Networks.

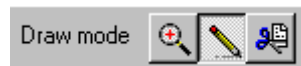
When you have chosen the file and clicked the *open* button, it will be read in and you will see a display similar to that of Figure 4.4. You can now edit this network, change any parameters or perform the calculation.



**Figure 4.7** The file menu showing the “Read Network” option.

## 2. To draw a new network:

To start drawing you need to be in “Draw mode”. Click on the Draw Mode button (a picture of a yellow pencil) (Figure 4.8).



**Figure 4.8** Draw Mode button.

Press the left mouse while on the white panel, keep it pressed, move the mouse, and a grey line will be drawn. When you release the mouse button the line will turn blue, indicating a sewer, and there will be a maroon square at each end indicating junctions. The sewer and the junctions will all have default names chosen by the program. These can easily be changed later. Do the same again with the mouse and you can draw several more sewers.

### ***Zooming in and out***

To zoom in and out of the sewer diagram you need to be in “Zoom mode”. To switch to zoom mode, press the Zoom Mode button shown in Figure 4.9.



**Figure 4.9** Zoom Mode button.

To zoom in, click the left mouse button. To zoom out click the right mouse button. The position of the click moves to the centre of the panel. Note that text and

junctions do not change size. The amount of zoom (scaling) is shown in the status bar at the base of the window (Figure 4.6).

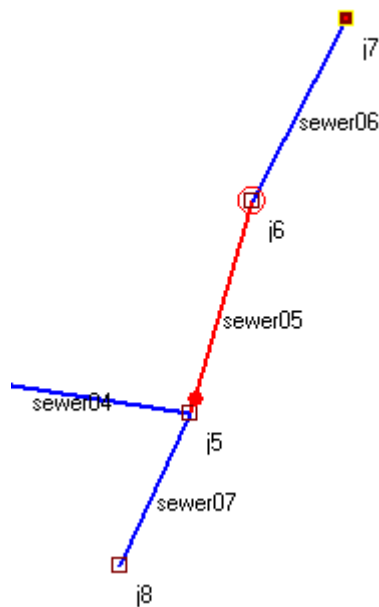
### ***Displaying and changing details of a sewer***

Change to “Edit mode” by clicking the button shown in Figure 4.10 and choose “Sewer” from the two options in the “Item to select” box next to it.



**Figure 4.10** Edit Mode button and selector.

Now click (left or right button) on the white panel. The nearest sewer will turn red (Figure 4.11) and its details will be displayed on the panel to the right (Figure 4.12).



**Figure 4.11** A highlighted selected sewer.

Sewer Name	sewer05
Length (m)	20.00
U/S Junction name	j6
<input type="button" value="Set this junction as datum"/>	
D/S Junction name	j3
D/S Drop junction	<input type="checkbox"/>
Initial infiltration (l/day)	0
Final infiltration (l/day)	0
Number of people using this sewer (i.e. feeding to upstream junction)	
<input checked="" type="radio"/> Houses <input type="radio"/> Population	
Initial num. of houses	1
Final num. of houses	1

**Figure 4.12** Details of selected sewer.

A sewer has the following properties:

1. Name,
2. Length (in metres),
3. Upstream junction name,
4. Downstream junction name,
5. Whether the U/S junction is a datum, and if so its level,
6. Whether the D/S junction is a drop junction,
7. Initial infiltration rate (in litres per day),
8. Final expected infiltration rate (in litres per day), and
9. Description of the initial and final number of people connected to the sewer (i.e. number of houses linked to the upstream junction).

In the example shown in Figure 4.12, sewer “sewer05” is 20m long, its upstream junction is named j6 and its downstream junction j5. From the details we cannot tell whether the upstream junction is a datum, but from the screen view (Figure 4.11) we can see that it is not as it is not marked with a yellow box. The sewer has no initial infiltration and none expected at the end of its life. Initially one house is linked to the upstream junction, and at the end of its life there will still only be one house connected. An increase in population can be designed for by changing the *average number of people per house* in the initial and final calculations – this is done on the Results Table screen. An alternative would be to specify the initial and final number of people in the houses that connect to the sewer.

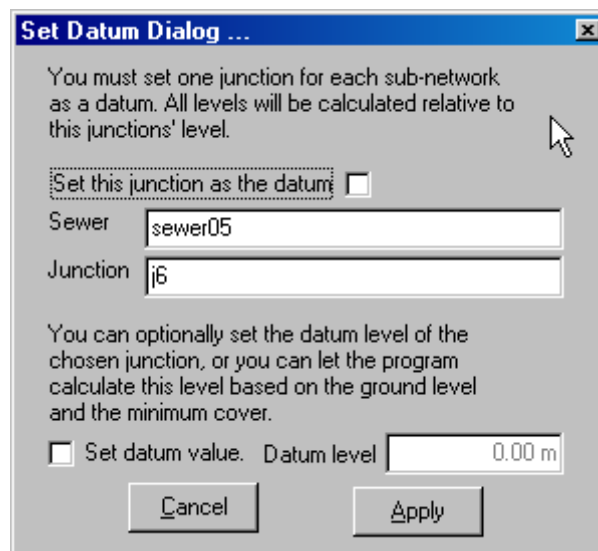
Any of the above values may be altered in the Edit box – as you type, the text colour will change to red. It will change to black when you click on another box – if it does not change back to black, it has not been recorded!

To change the name of the sewer, simply type a new name. Clicking on the next box or clicking the “Apply Changes” button will change the text colour to black and record the change. (Note that the Apply Changes button does not need to be pressed if the colour has changed – but it does no harm to press it!)

In this example you can see that “sewer05” has a upstream junction named “j6” and a downstream junction “j5”. To change this connectivity, just select a different junction from the list for either the upstream (U/S) or downstream (D/S) junction name.

### ***Datum setting***

All sub-nets need one junction to be specified as the datum junction. To do this you select the sewer whose upstream junction will be the datum. Then on the Sewer Details panel click on the “Set this junction as datum” button. This will display the dialog box shown in Figure 4.13.



**Figure 4.13** Datum setting dialog.

Click the check box to set the junction shown as the datum. You can specify the actual datum invert level by clicking the “Set datum value” check box and entering a value. Alternatively, and more conveniently, uncheck this check box (as shown in Figure 4.13) which will tell the program to calculate a datum level based on the ground level of the junction and the minimum cover. You will need to press the “Apply” button to save this information and close the dialog box.

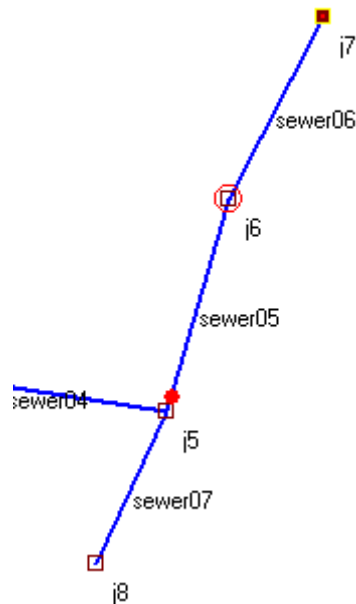
When attempting to do the calculation, you will be given a warning if there is no datum set or if there is more than one for any particular sub-net.

### ***Deleting sewers***

Clicking on the “Delete Sewer” button (Figure 4.4) will give you the option to delete the selected sewer or not. Note that the attached junctions will not be deleted (as you may want to use them). To delete junctions, see below.

### ***Displaying, repositioning and changing details of a junction***

As with the sewer details, change to Edit mode by clicking the button shown in Figure 4.10. This time choose “Junction” from the two options in the “Item to select” box next to it.



**Figure 4.14** Highlighted selected junction.

To reposition a junction, left click on the white panel, the nearest junction will be highlighted with a red circle – see junction j6 in Figure 4.14. By moving the mouse while still pressed, the position of the junction and the sewers connected to it can be changed.

[Note again that this position, and sewer length change, is only a convenience for viewing; it does not necessarily represent what the network looks like on the ground. The simplified sewerage system does not take into account the orientation of individual sewers – only their gradient. However, it is probably useful to draw the network so that it is at least *similar* to the expected layout.]

To highlight the junction without moving it, right-click the mouse near a junction. Details will be displayed on the right panel – see Figure 4.15.

Like sewers, junctions also have properties that are displayed when clicking on the junction. There are only two properties:

1. Name, and
2. Ground level (in metres).

These properties may be changed on the Details panel to the right (Figure 4.15).



**Figure 4.15** Details panel for junctions.

### ***Deleting junctions***

Clicking on the “Delete Junction” button will give you the option to delete the selected junction – but only if the junction is currently not connected to a sewer. If it is attached to a sewer, you must first delete the connected sewer before deleting the junction.

### ***Changing what is displayed***

To change how much detail is displayed on the screen there are seven “Display option” buttons, as shown in Figure 4.16.



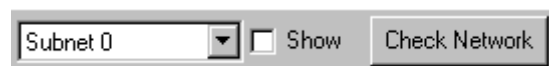
**Figure 4.16** Display option buttons.

The first six toggle on and off to show sewers, junctions, sewer names, junction names, drop junctions and datum junctions, respectively.

The seventh button scales the network so that it is all shown in the window.

### ***Displaying of sub-nets***

To the right of the tool bar are three controls for viewing sub-nets (Figure 4.17): a drop down list selector to choose the sub-net to highlight, an option to show the sub-net or not and a button labelled “Check Network”. Initially the selection list is empty, and no sub-net can be shown. Before they can be shown the network must be checked for consistency of the sub-nets. Pressing the Check Network button does this. If the network passes the connectivity check, the selector list will automatically be filled with the names of the existing sub-nets. Check the “Show” box and the chosen sub-network will be displayed in green.



**Figure 4.17** Sub-network display controls.

## 4.3 DATA ENTRY/EDIT SCREEN

This screen (Figure 4.18) presents a series of tables and boxes to allow you enter (or edit) data to describe the sewer network layout, and usage requirements.

The screenshot shows the 'Simplified Sewerage' software interface. The 'Data Entry/Edit' tab is active. The 'List of Sewers' table on the left contains the following data:

Sewer ID
sewer01
sewer02
sewer03
sewer04
sewer05
sewer06
sewer07

The 'List of Junctions' table on the right contains the following data:

Junction ID
j1
j2
j3
j4
j5
j6
j7
j8

The form for sewer07 includes the following fields and values:

- Sewer Name: sewer07
- Length (m): 10.00
- Initial infiltration (l/day): 0
- Final infiltration (l/day): 0
- U/S Junction name: j5
- D/S Junction name: j8
- D/S Drop junction:
- Number of people using this sewer (i.e. feeding to upstream junction):
  - Houses:
  - Population:
- Initial num. of people: 0
- Final num. of people: 0

The form for junction j5 includes the following fields and values:

- Junction Name: j5
- Ground level (m): 97.00

**Figure 4.18** The Data Entry/Edit Screen with example data.

Figure 4.18 shows the lists and boxes filled in for a typical example (details of this example network can be found in Section 4.7.3.) This example is stored in the sewer network file *example03.snt*. These files all have the extension “.snt”. An .snt file contains the network description as well as the calculated details – sizes, slopes, depths etc. – if they have been calculated. These files may be easily read, saved and read back into the program. From this data entry screen the button labelled “Read Network” (Figure 4.19) will open a dialog allowing you to choose one of these files and load it into the program.

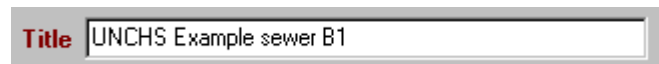


**Figure 4.19** The Read Network button.

You have the choice to either use an old network file or create a new one. If you read one in, you may freely edit and change its configuration to the new design. However, it may sometimes be more convenient to start a new network.



You may enter a network, or project, title in the Title Edit box (Figure 4.20). This title will be saved in the .snt file and appear on graphs and other printouts of the solution.



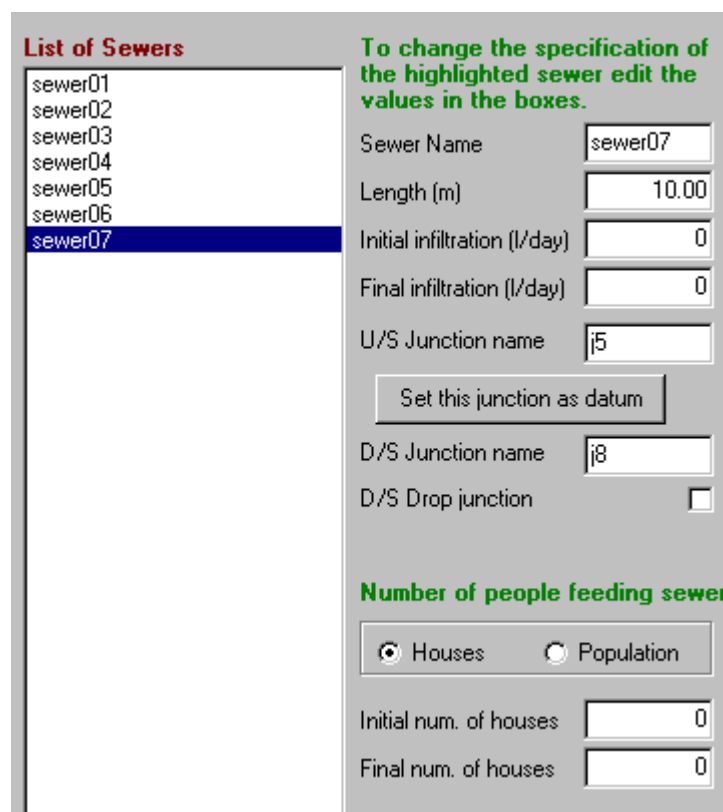
The image shows a rectangular box with a grey border. On the left side, the word "Title" is written in red. To the right of "Title" is a white text input field containing the text "UNCHS Example sewer B1".

**Figure 4.20** The Title Edit box.

A sewer network is made up of named sewers that join at named junctions. Thus each sewer has an upstream and a downstream junction. Sewers and junctions each have their own properties (see below) which in total describe the sewer layout and the wastewater flows for which the design will be made.

This screen provides an alternative to the Visual Edit screen for entering, displaying and editing all of the network and demand properties.

The names of all the sewers are listed in the Sewer List box (Figure 4.21). Clicking on any one of these displays the properties of that sewer in the edit boxes to the right.



The image shows a software interface with two main sections. On the left, under the heading "List of Sewers", is a list box containing the following items: sewer01, sewer02, sewer03, sewer04, sewer05, sewer06, and sewer07. The item "sewer07" is highlighted with a blue background. On the right, there is a panel for editing the selected sewer. At the top of this panel, green text reads: "To change the specification of the highlighted sewer edit the values in the boxes." Below this text are several input fields: "Sewer Name" (containing "sewer07"), "Length (m)" (containing "10.00"), "Initial infiltration (l/day)" (containing "0"), "Final infiltration (l/day)" (containing "0"), "U/S Junction name" (containing "j5"), and "D/S Junction name" (containing "j8"). There is a button labeled "Set this junction as datum" below the U/S Junction name field. Below the D/S Junction name field is a checkbox for "D/S Drop junction", which is currently unchecked. At the bottom of the panel, there is a section titled "Number of people feeding sewer" with two radio buttons: "Houses" (which is selected) and "Population". Below these are two more input fields: "Initial num. of houses" (containing "0") and "Final num. of houses" (containing "0").

**Figure 4.21** The Sewer List Box and Sewer Data Edit boxes.

### ***Editing sewer properties***

See Section 4.3 (under the heading *Displaying and changing details of a sewer*) for a detailed description of the sewer properties that need to be entered.

Many of the sewer properties may be altered in the edit boxes – the text colour will change to red. It will change back to black when you click on another box – if it does not change back to black, it has not been recorded!

If a junction name is entered that does not appear in the junction list on the right, that name is automatically created and displayed as a new junction on the list.

A new sewer can be added to the network by pressing the right mouse button in the sewer list box and selecting Add Sewer (Figure 4.22). The sewer is given a unique name and default property values which must be edited to fit in the network.



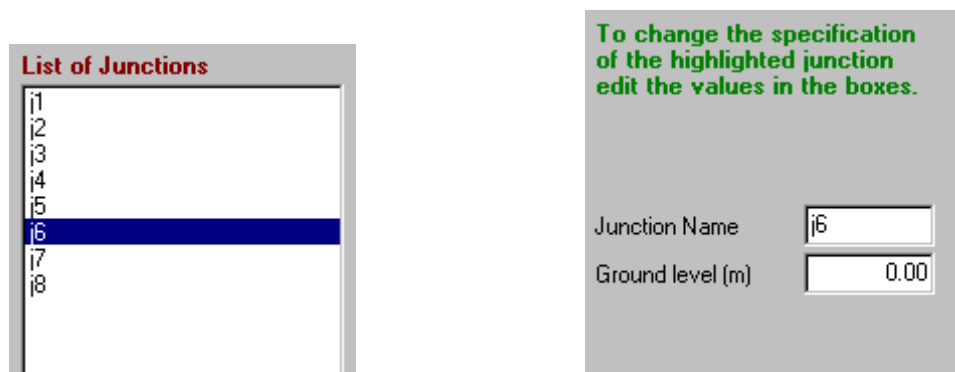
**Figure 4.22** The Add/Delete options for Sewer/Junction when right-clicking the list .

To remove a selected sewer from the network choose the Delete Sewer option. You will be prompted to confirm this deletion to help prevent accidental removal.

### ***Editing junction properties***

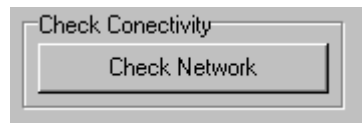
Like sewers, junctions also have properties that are displayed when clicking on the junction name in the junction list box (Figure 4.23). These properties are described in detail in Section 4.3 (under the heading *Displaying, repositioning and changing details of a junction*).

Again, as for sewers, the junction properties may be edited and the changes recorded by pressing the Apply Change button below the Junction Data Edit box.



**Figure 4.23** The Junction List and Junction Data Edit boxes.

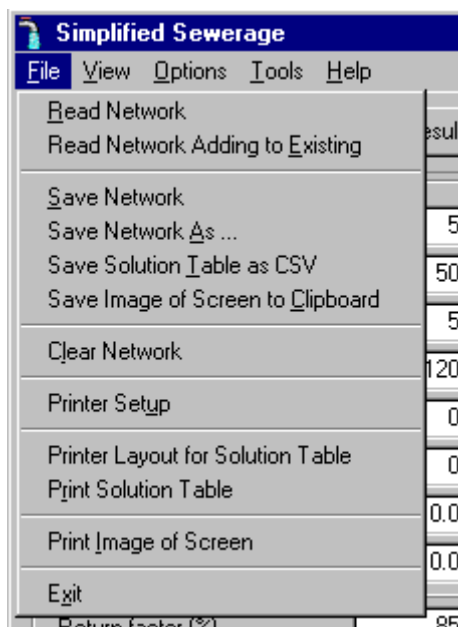
Once the sewers and junctions have been specified, the sewer network description is complete. It is necessary to perform some checks to ensure that it is described correctly and that it does not contain any loops. To perform these checks, press the Check Network button shown in Figure 4.24.



**Figure 4.24** The Check Network button.

A network may be valid and correct with junctions that are not connected anywhere. It may be that these are placed with the expectation that new sewers will join them later. On the other hand it may be better to remove them to keep the network tidy. To remove all unconnected junctions choose the Options menu so that the item “Delete Unused Junctions” (see Section 4.6 for all menu details) is checked *before* pressing the Check Network button. (You could also remove the surplus junctions one by one by clicking on their name in the junction list box and pressing the Delete Junction button shown in Figure 4.22.)

Once the network has been entered and checked, it should be saved before going any further. As mentioned above, sewer networks should be saved to .snt files. To save a sewer network, choose File from the main menu bar, and select either Save Network or Save Network As ... (Figure 4.25); the latter option allows you to save it under a new name.



**Figure 4.25** The File Menu showing the “Save Network” options.

This saved file can be read in again during this session on the program or at any time in the future when the network description will be again be displayed in the tables exactly as it was saved.

After entering and saving the network, go on to the Results Table screen by pressing the Results Table button on the top tool-button bar. A solution will be automatically calculated and displayed.

## 4.4 RESULTS TABLE SCREEN

This screen (Figure 4.26) presents the designed sewer network. All the required data for constructing the sewer are shown in this table.

Sewer	Length (m)	Initial u/s flow (l/s)	Initial Infiltration	Initial flow (l/s)	Total Initial flow (l/s)	Final u/s flow (l/s)	Final Infiltration	Final flow (l/s)	Total final flow (l/s)	u/s Junct. name	d/s Junct. name	E u
sewer01	10.00	0.000E+00	0.000E+00	2.894E-03	1.500	0.000E+00	0.000E+00	2.894E-03	1.500	j1	j2	1
sewer02	8.00	2.894E-03	0.000E+00	2.894E-03	1.500	6.944E-03	0.000E+00	2.894E-03	1.500	j2	j3	9
sewer03	7.00	5.787E-03	0.000E+00	5.787E-03	1.500	1.389E-02	0.000E+00	5.787E-03	1.500	j3	j4	9
sewer04	9.00	1.157E-02	0.000E+00	2.894E-03	1.500	2.778E-02	0.000E+00	2.894E-03	1.500	j4	j5	9
sewer05	20.00	2.894E-03	0.000E+00	2.894E-03	1.500	6.944E-03	0.000E+00	2.894E-03	1.500	j6	j5	9
sewer06	10.00	0.000E+00	0.000E+00	2.894E-03	1.500	0.000E+00	0.000E+00	2.894E-03	1.500	j7	j6	9
sewer07	10.00	2.025E-02	0.000E+00	0.000E+00	1.500	4.861E-02	0.000E+00	0.000E+00	1.500	j5	j8	9

**Figure 4.26** The Results Table screen.

If a sewer network has been previously entered – by reading from an existing file, via either the Data Entry/Edit or Visual Editor screens – then the solution will be automatically shown when this screen is displayed.

**Note:** You cannot edit the values in this table. To obtain a different solution you must edit the initial data and/or the calculation parameters.

Each column of the table has a heading, shown more clearly in Figure 4.27, which identifies the parameter found there for each sewer. The data for each sewer are written on a single row, and the sewer is identified by its name in the first column headed "Sewer".

Sewer	Length (m)	Initial u/s flow (l/s)	Initial Infiltration	Initial flow (l/s)
sewer01	10.00	0.000E+00	0.000E+00	2.894E-03
sewer02	8.00	2.894E-03	0.000E+00	2.894E-03
sewer03	7.00	5.787E-03	0.000E+00	5.787E-03
sewer04	9.00	1.157E-02	0.000E+00	2.894E-03
sewer05	10.00	5.787E-03	0.000E+00	0.000E+00

**Figure 4.27** A sample of the Results Table.

The table will normally be wider and longer than your monitor screen; the columns and rows that are not visible can be viewed by moving the bottom and right scroll bars. Each column width may be changed (widened or narrowed) by placing the mouse cursor over the line separating any heading; when the cursor changes to two vertical lines, press the left mouse button – moving the mouse will then adjust the column widths of the two adjacent columns.

As well as displaying the solution, this screen also allows the setting of parameters for the *whole* network (the Data Entry/Edit screen allows setting of data for individual sewers of the network). These “global” settings are made by changing the values in the edit boxes above the table.

The default values which appear on this screen have been chosen to be those (or very close to those) that should be used. Great care should be taken when using parameter values that differ greatly from these default values.

The parameter setting will now be explained. The first column of four edit boxes (Figure 4.28) deals with water consumption which, together with the population setting from the Data Entry/Edit screen of each sewer (Figure 4.21) define the water use. If “Population” was chosen to define use, then only the top two boxes – initial and final consumption – need be set. However, if “Houses” was chosen, then the lower two boxes – the initial and final mean number of people per house – are also required to define the total number of people using the sewer and hence the total water use.

Initial water consumption (lcd) (litres/day)	<input type="text" value="50"/>
Final water consumption (lcd) (litres/day)	<input type="text" value="120"/>
Initial mean number of people per house	<input type="text" value="5"/>
Final mean number of people per house	<input type="text" value="5"/>

**Figure 4.28** Water consumption data edit boxes.

The rest of the settings deal with how the sewer design calculations are to be performed.

Minimum self-cleansing velocity (m/s)	<input type="text" value="0.50"/>
Minimum tractive tension (N/m <sup>2</sup> , Pa)	<input type="text" value="1.00"/>
G-Manning's n	<input type="text" value="0.0130"/>
Minimum sewer cover (m)	<input type="text" value="0.40"/>

**Figure 4.29** Calculation parameters.

Figure 4.29 shows the options to set either the minimum self-cleansing velocity or minimum tractive tension, or both. (Only one solution will be displayed based on one of these methods; however both calculations are performed, so both values should be entered.) The value for Gaukler-Manning's  $n$  (shown as G-Manning's  $n$ ) may also be set in the next edit box. The minimum cover of sewer is the depth set for the upstream junction that has been designated as the datum junction. All other depths will be calculated relative to this according to the calculated sewer gradients.

Return factor (%)	<input type="text" value="85"/>
Peak flow factor	<input type="text" value="1.80"/>
<input type="radio"/> Min Vel <input checked="" type="radio"/> Min Tau	

**Figure 4.30** Calculation parameters.

Figure 4.30 shows the edit boxes for Return Factor (entered as a percentage) and Peak Flow Factor. Also shown is the choice of calculation for which results will be presented – Min Vel refers to the calculation based on minimum self-cleansing velocity, while Min Tau refers to that based on minimum tractive tension.

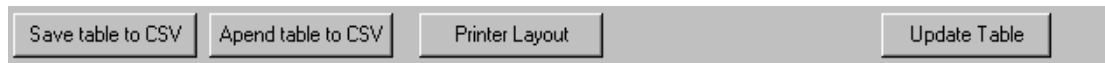
It may be desirable to set some design limits for the calculation. Three check boxes are provided for this (Figure 4.31). Ticking the Minimum Flow check box means that if the sewer demand is less than the minimum entered in the edit box to the right, then this minimum is used for the sewer design. Ticking the Minimum Diameter check box means that no sewer of diameter less than the entered minimum will be used. Ticking the Ground Slope Limiting box means that the minimum slope of the sewer will not be less than the ground slope.

Minimum flow (litres/s)	<input checked="" type="checkbox"/>	<input type="text" value="1.50"/>
Minimum diameter (mm)	<input checked="" type="checkbox"/>	<input type="text" value="100"/>
Ground slope limiting	<input checked="" type="checkbox"/>	
<input checked="" type="radio"/> G-Manning <input type="radio"/> CW <input type="radio"/> Escriott		

**Figure 4.31** Limiting values and Velocity of Flow equations.

Also shown in Figure 4.31 is the choice of velocity of flow equation – Gaukler-Manning (shown as G-Manning), Colebrook White (shown as CW) or Escriott.

When changes have been made to any parameters, to see what effect these changes have on the solution the Update Table button (located below the table – Figure 4.32) must be pressed. The table will then be updated with the new results.



**Figure 4.32** The buttons below results table.

The other three buttons shown in Figure 4.32 allow the saving and printing of the solution. The first two buttons save to CSV files (CSV files contain data from the Results table with each item of data being separated by a comma – thus CSV from “comma separated variable”). This format of file can be easily read into most spreadsheet programs (including Microsoft Excel), so enabling further processing or presentation in reports. The Save Table to CSV button allows saving to a new or existing file; and the Append Table to CSV button adds the data in the table to the bottom of an existing file; this is useful if several scenarios are to be tested and analysed later.

The Print Page Layout button opens a dialog to allow the setting of print options – page margin, orientation etc. The Print Preview button allows a preview of the page; you may also print directly from this preview screen.

Should it be necessary to examine the detail of a calculation for a particular sewer, then choose that sewer (just click on a particular row of the table) and press the Calculator button on the main Tool Button Bar (Figure 4.2). The calculation screen will be displayed containing full details of the calculation performed and solutions obtained for that sewer. This screen is described in detail in Section 4.5.

## 4.5 CALCULATOR SCREEN

This screen (Figure 4.33) presents the detail of the calculation for an individual sewer. Opening the screen automatically displays the design parameters for the current sewer of the Results Table (the last sewer row to be clicked on or highlighted on the Visual Edit screen).

This screen allows the calculation to be performed with new demand data or new calculation parameters, so that changes in design can be investigated. Any changes made to this screen are **not** transferred to the Results Table of sewer data.

To the left hand side of the screen are displayed all the design parameters; these have been taken from those previously entered on the either the Data Entry/Edit or Results Table screens.

The first eight of the edit boxes for the design parameters deal with the sewer's initial and final demand in terms of population and water consumption (Figure 4.34); see Section 4.2 for a description of these.

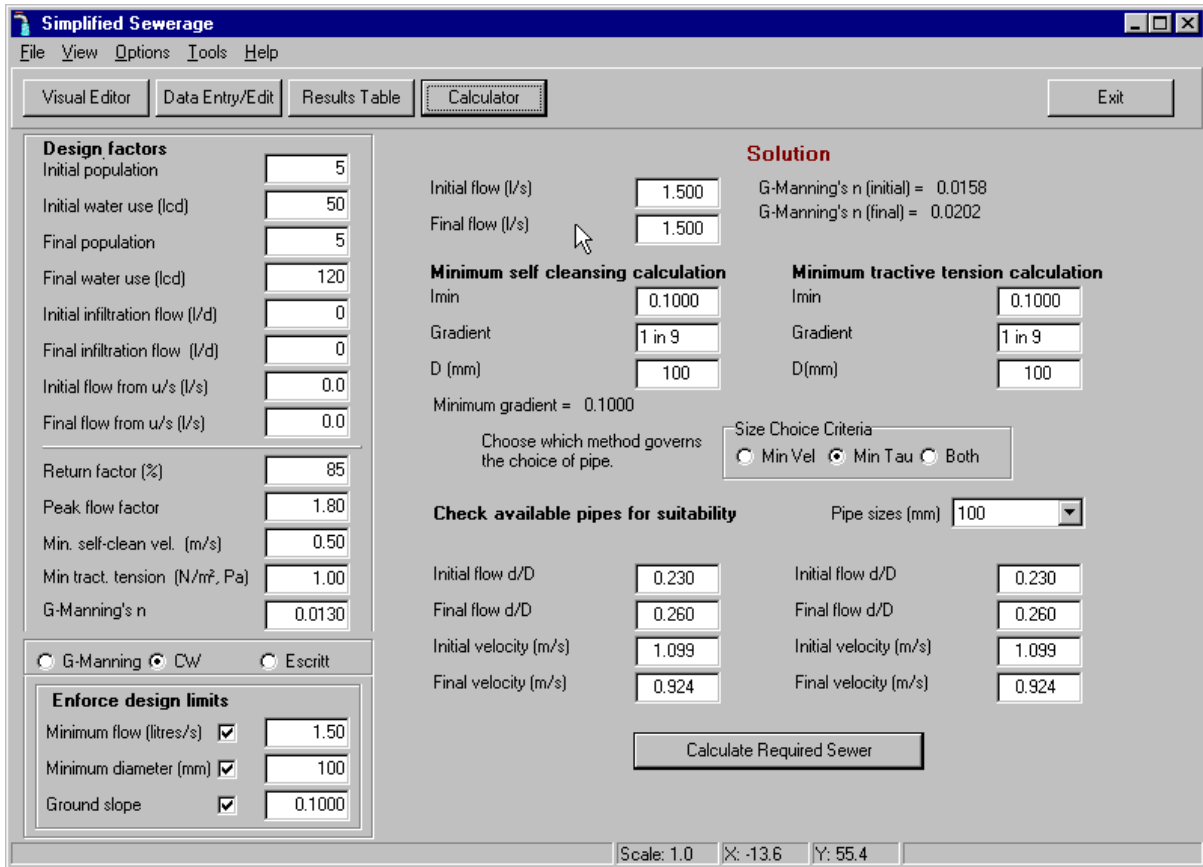


Figure 4.33 Sewer Calculation screen.

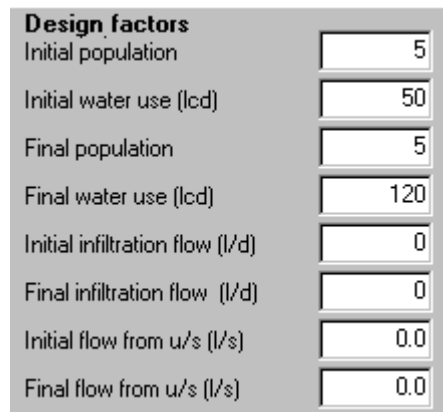


Figure 4.34 Water consumption settings.

Below these the design parameters (Figure 4.35) and design limits (Figure 4.36) are displayed.



Return factor (%)	<input type="text" value="85"/>
Peak flow factor	<input type="text" value="1.80"/>
Min. self-clean vel. (m/s)	<input type="text" value="0.50"/>
Min tract. tension (N/m <sup>2</sup> , Pa)	<input type="text" value="1.00"/>
G-Manning's n	<input type="text" value="0.0130"/>
<input type="radio"/> G-Manning <input checked="" type="radio"/> CW <input type="radio"/> Escritt	

**Figure 4.35** Design parameters.

Enforce design limits		
Minimum flow (litres/s)	<input checked="" type="checkbox"/>	<input type="text" value="1.50"/>
Minimum diameter (mm)	<input checked="" type="checkbox"/>	<input type="text" value="100"/>
Ground slope	<input checked="" type="checkbox"/>	<input type="text" value="0.1000"/>

**Figure 4.36** Design limits.

Note that you may change the ground slope here; this is not possible on the Results Table form as that would entail changing junction/network data. It is possible here as this screen is only concerned with a single sewer.

The Calculator screen shows results of calculations based on both minimum self-cleaning velocity and minimum tractive tension. The results are displayed side-by-side, as shown in Figure 4.37.

Solution			
Initial flow (l/s)	<input type="text" value="1.500"/>	G-Manning's n (initial) =	0.0158
Final flow (l/s)	<input type="text" value="1.500"/>	G-Manning's n (final) =	0.0202
<b>Minimum self cleansing calculation</b>		<b>Minimum tractive tension calculation</b>	
I <sub>min</sub>	<input type="text" value="0.1000"/>	I <sub>min</sub>	<input type="text" value="0.1000"/>
Gradient	<input type="text" value="1 in 9"/>	Gradient	<input type="text" value="1 in 9"/>
D (mm)	<input type="text" value="100"/>	D (mm)	<input type="text" value="100"/>
Minimum gradient = 0.1000			
Choose which method governs the choice of pipe.		Size Choice Criteria	
		<input type="radio"/> Min Vel <input checked="" type="radio"/> Min Tau <input type="radio"/> Both	

**Figure 4.37** The two solutions side by side.

The calculated gradient and diameter of the sewer for both calculations are shown in Figure 4.37 (the diameter may be the set minimum if that option was chosen). If the gradient is limited by the ground slope, then this limit will be shown as the minimum gradient.

The total initial and final flows are calculated and displayed at the top of the screen. If either the Colebrook-White or Eschritt equations have been chosen, then the *equivalent* Gauckler-Manning's *n* is displayed next to these (Figure 4.38).

In Figure 4.39 the chosen sewer (from the list of available sewers) is displayed and, to enable a check on the solution, so are the d/D and velocity values for the initial and final flows. (Remember d/D should always be greater than 0.2 and the minimum velocity should be greater than that set – if this was the chosen design method.)

**Figure 4.38** Check sewer design.

**Figure 4.39** Chosen sewer selector.

## 4.6 MAIN MENU OPTIONS

The Menu bar at the top of the screen allows an alternative way to perform several of the operations available on the four main screens, as well as offering some additional functionality.

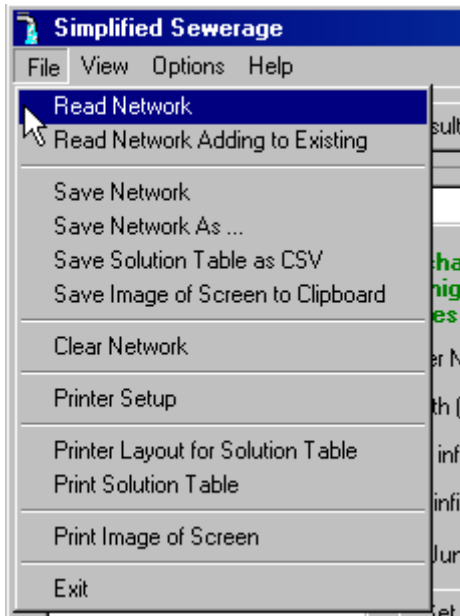
### 4.6.1 File Menu

The File menu (Figure 4.40) allows you to save and read the network description using the Save Network and Read Network options.

The Clear Network option deletes all entered data and starts a new network – so **be careful** with this option!

The Save Solution Table as CSV option allows saving of the results table to a CSV file – see the description of the Results Table screen (Section 4.4) for a full explanation of this.

The Save Image of Screen to Clipboard option makes a copy of the program screen in the Windows clipboard – you may then copy this into your word processor by choosing the paste function (or pressing keys Ctrl-V) from within that program. This may be useful for including design details in reports.

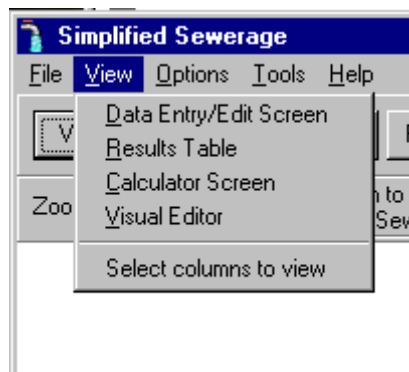


**Figure 4.40** File Menu.

The next four options deal with printing the results. Print Setup allows you to choose which printer and paper to use. Print Image of Screen will print the displayed program screen on the chosen (or default) printer.

#### 4.6.2 View Menu

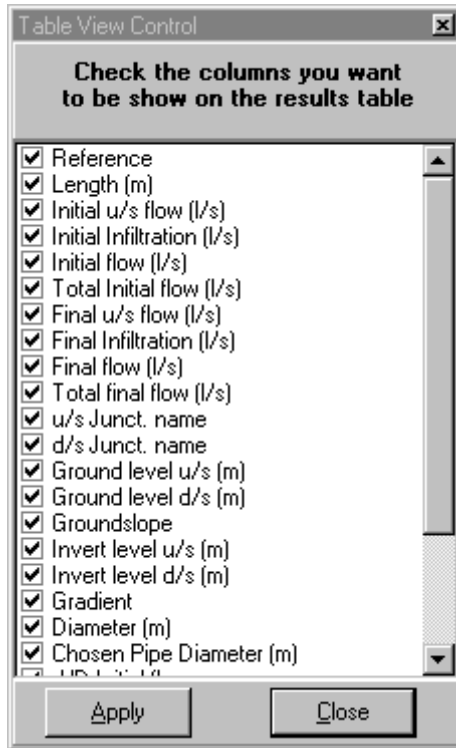
The View menu has five options (Figure 4.41). The first four reproduce the functionality of the first four buttons of the main toolbar (Figure 4.2), i.e. they enable switching between the four main forms of the program.



**Figure 4.41** The View menu.

The fifth option opens a window that allows control of the appearance of the Result Table. This window is shown in Figure 4.42.

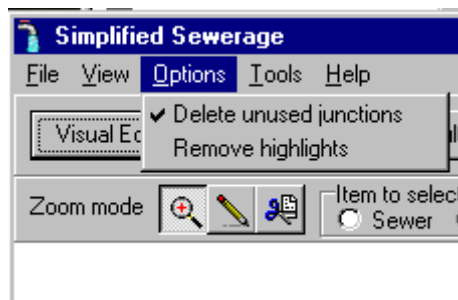
The window contains a list of the headings for each column of the Results Table. If the adjacent check box is ticked, then that column will be displayed in the Results Table. By default all columns are shown. To view any change in the Results Table press the Apply button.



**Figure 4.42** Table View Control window.

### 4.6.3 Options Menu

The Options menu gives two choices. The first item “Delete unused junctions” can be ticked on or off (Figure 4.43 shows it on). When on, any unused junctions (i.e. those not associated with a sewer) will be deleted when a check on the network is performed.



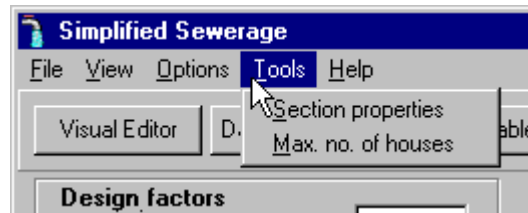
**Figure 4.43** The Options menu.

It is sometimes useful not to have these deleted – for example, when you wish to use the junction at a later time, but wish to check its current connectivity.

The “Remove highlights” option refers to any sewer or junction that has been displayed (highlighted) in red on the Visual Editor screen. Choosing this item will clear this highlighting.

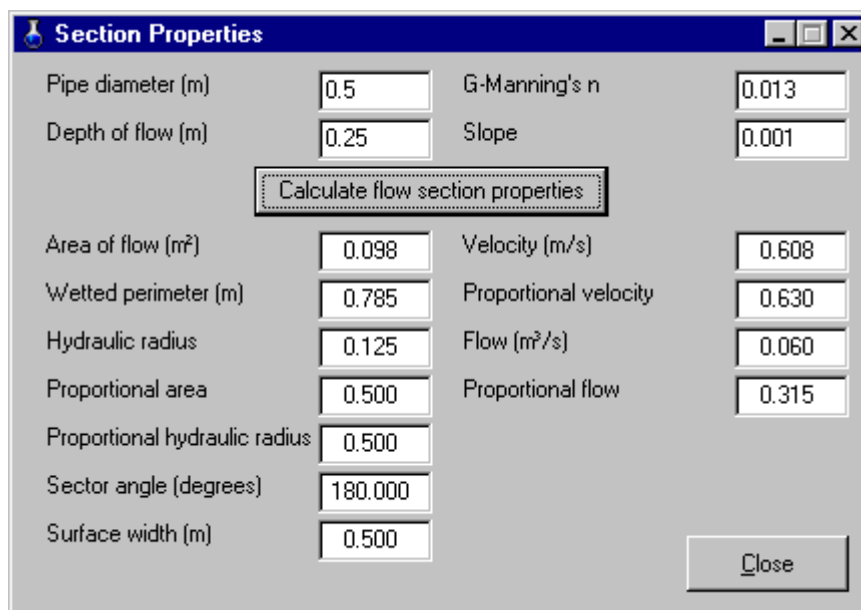
#### 4.6.4 Tools Menu

The Tools menu displays two items that give access to small “helper” screens that appear when the item is chosen.



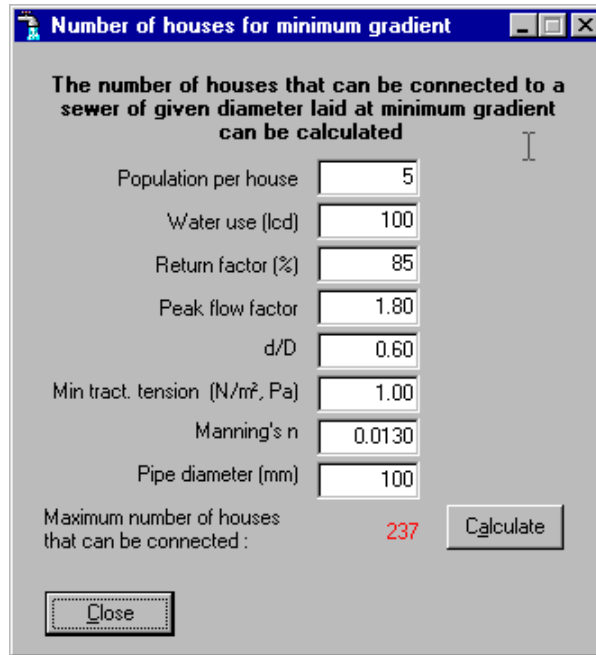
**Figure 4.44** The Tools Menu.

The “Section properties” item displays the screen shown in Figure 4.45. This screen allows quick calculation of the hydraulic properties of circular channels.



**Figure 4.45** The Section Properties Helper screen.

The second item “Max. no. of houses” shows a screen (Figure 4.46) that allows a quick calculation of the number of houses that can be safely connected to a minimum sized sewer at minimum gradient, based on the minimum flow (single WC flush) (see Section 3.3.6).

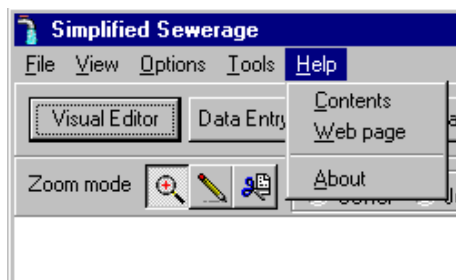


**Figure 4.46** The Minimum Gradient Helper screen.

#### 4.6.5 Help Menu

The Help Menu has three items, which are typical choices for Windows-based programs. “Contents” brings up the help pages which should help answer most queries about how to use the program

If a query is not answered, it may be worthwhile choosing the second option “Web page” which will attempt to open the PC’s standard web browser in order to connect to the web support page for the program.



**Figure 4.47** The Help Menu.

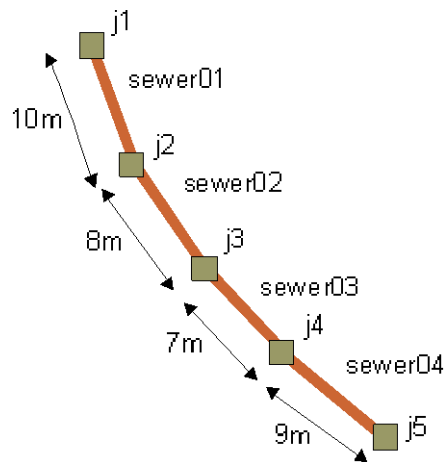
The “About” item displays useful program and author details.

## 4.7 QUICK START EXAMPLES

These four worked examples demonstrate all the steps necessary to build simple sewer networks. These examples also demonstrate the use of some of the calculation options. Data for all four examples can be found in the Networks directory where the program was installed.

#### 4.7.1 Example 1 – A single line of sewers

This example is a simple series of four connected sewers joined as shown in Figure 4.48.



**Figure 4.48** Example 1 sewer layout.

The first thing to do before entering the sewer network data on the Data Entry/Edit screen is to draw your system of sewers on paper and label each junction and sewer in a similar way to that shown in Figure 4.48; this will make the job of data entry much easier.

As a minimum to get your basic layout entered you will also need the following for each sewer: its length, and the number of people using the sewer (this may be described in terms of the number of houses connected together with a mean number of people per house, or in terms of a single total number of people who live in houses connected to the sewer). This example will specify the number of houses connected. For each junction (or node) of the network the ground level is required.

The data for this example are as follows:

Sewer name	Length (m)	Number of houses connected
Sewer01	10	1
Sewer02	8	1
Sewer03	7	2
Sewer04	9	1

Junction name	Ground level (m)
j1	100.0
j2	99.0
j3	98.0
j4	97.0
j5	97.0

To enter the data display the Data Entry/Edit screen. First enter a title for the network in the edit box next to the label "Title". This will appear on saved results and printouts. To input the sewer data first create the sewers by pressing right mouse button and choosing the "Add Sewer" option (see Figure 4.22). Do this **four** times. This will create four new sewers with the names S0, S1, S2 and S3, all with the same default data. These can now be edited to represent the above network.

Click on S0 in the list of sewers and change the sewer name to sewer01, the length to 10.00, the upstream junction to j1 and the downstream junction to j2. Click on the "Houses" option so that a black dot appears next to the label "Houses" and enter 1 in both the initial and final number of houses edit boxes. The data in the edit boxes should now look like those in Figure 4.49.

All names and labels in this program are case sensitive. For example, a sewer named sewer01 is **not** the same as a sewer named Sewer01.

**Note:** as you type in any of the boxes on this screen the text will change to red indicating that the data have been changed. Clicking on the next box will change the text colour to black. Only when the text has changed colour back to black will the change be recorded.

The screenshot shows a software interface with a 'List of Sewers' on the left and a configuration panel on the right. The list contains 'sewer01', 'S1', 'S2', and 'S3', with 'sewer01' selected. The configuration panel includes fields for Sewer Name (sewer01), Length (m) (10.00), Initial infiltration (l/day) (0), Final infiltration (l/day) (0), U/S Junction name (j1), D/S Junction name (j2), and D/S Drop junction (unchecked). It also features radio buttons for 'Houses' (selected) and 'Population', and input boxes for Initial num. of houses (1) and Final num. of houses (1). A button 'Set this junction as datum' is located between the U/S and D/S junction name fields. A green instruction box at the top right reads: 'To change the specification of the highlighted sewer edit the values in the boxes.'

**Figure 4.49** Data for sewer01.

In a similar way enter the data for sewer02, sewer03 and sewer04, so that the data are as shown in Figures 4.50, 4.51 and 4.52, respectively.



**List of Sewers**

sewer01
<b>sewer02</b>
S2
S3

**To change the specification of the highlighted sewer edit the values in the boxes.**

Sewer Name

Length (m)

Initial infiltration (l/day)

Final infiltration (l/day)

U/S Junction name

D/S Junction name

D/S Drop junction

Number of people using this sewer (i.e. feeding to upstream junction)

Houses  Population

Initial num. of houses

Final num. of houses

**Figure 4.50 sewer02 data.**

**List of Sewers**

sewer01
sewer02
<b>sewer03</b>
S3

**To change the specification of the highlighted sewer edit the values in the boxes.**

Sewer Name

Length (m)

Initial infiltration (l/day)

Final infiltration (l/day)

U/S Junction name

D/S Junction name

D/S Drop junction

Number of people using this sewer (i.e. feeding to upstream junction)

Houses  Population

Initial num. of houses

Final num. of houses

**Figure 4.51 sewer03 data.**

**List of Sewers**

sewer01
sewer02
sewer03
<b>sewer04</b>

**To change the specification of the highlighted sewer edit the values in the boxes.**

Sewer Name

Length (m)

Initial infiltration (l/day)

Final infiltration (l/day)

U/S Junction name

D/S Junction name

D/S Drop junction

Number of people using this sewer (i.e. feeding to upstream junction)

Houses  Population

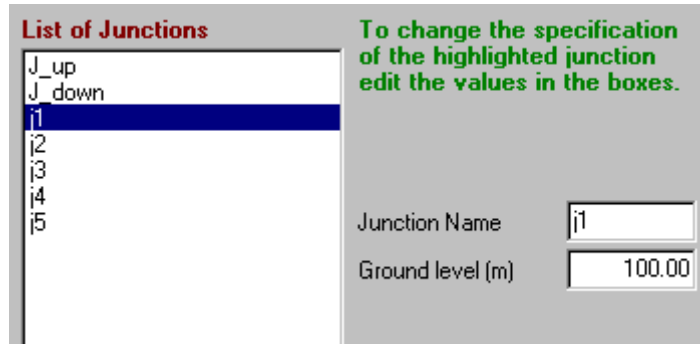
Initial num. of houses

Final num. of houses

**Figure 4.52 sewer04 data.**

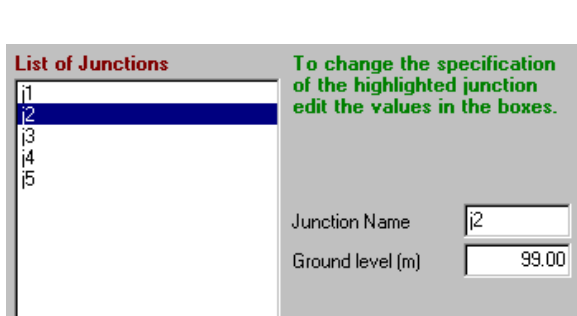
Now enter the junction data. There should be a list of seven junctions in the junction list – the five you have entered plus “J\_up” and “J\_down” which are default names; these may be left in or deleted. Leave them in for now.

Click on “j1” to display the junction data. Leave the name but enter the ground level as 100.00 m. The data should then appear as shown in Figure 4.53.

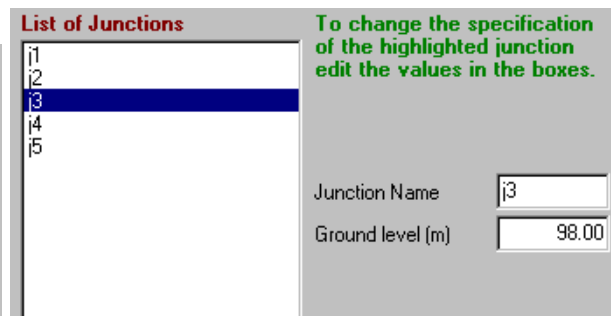


**Figure 4.53** Junction j1 data.

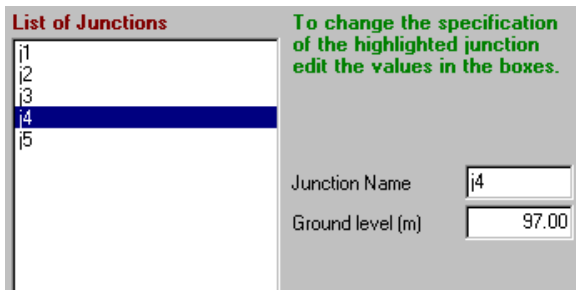
In the same way change the data for junctions j2, j3, j4 and j5 to appear as shown in Figures 4.54, 4.55, 4.56 and 4.57, respectively.



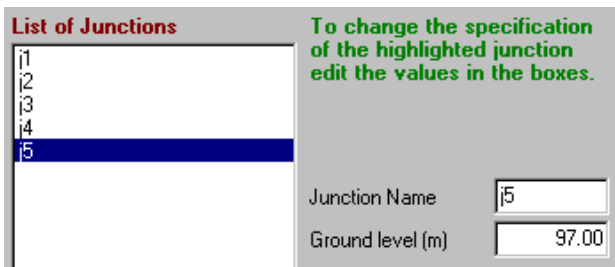
**Figure 4.54** Junction j2 data.



**Figure 4.55** Junction j3 data.

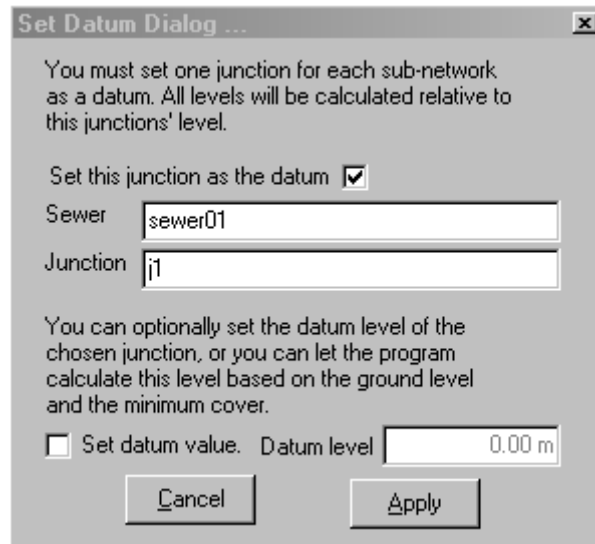


**Figure 4.56** Junction j4 data.



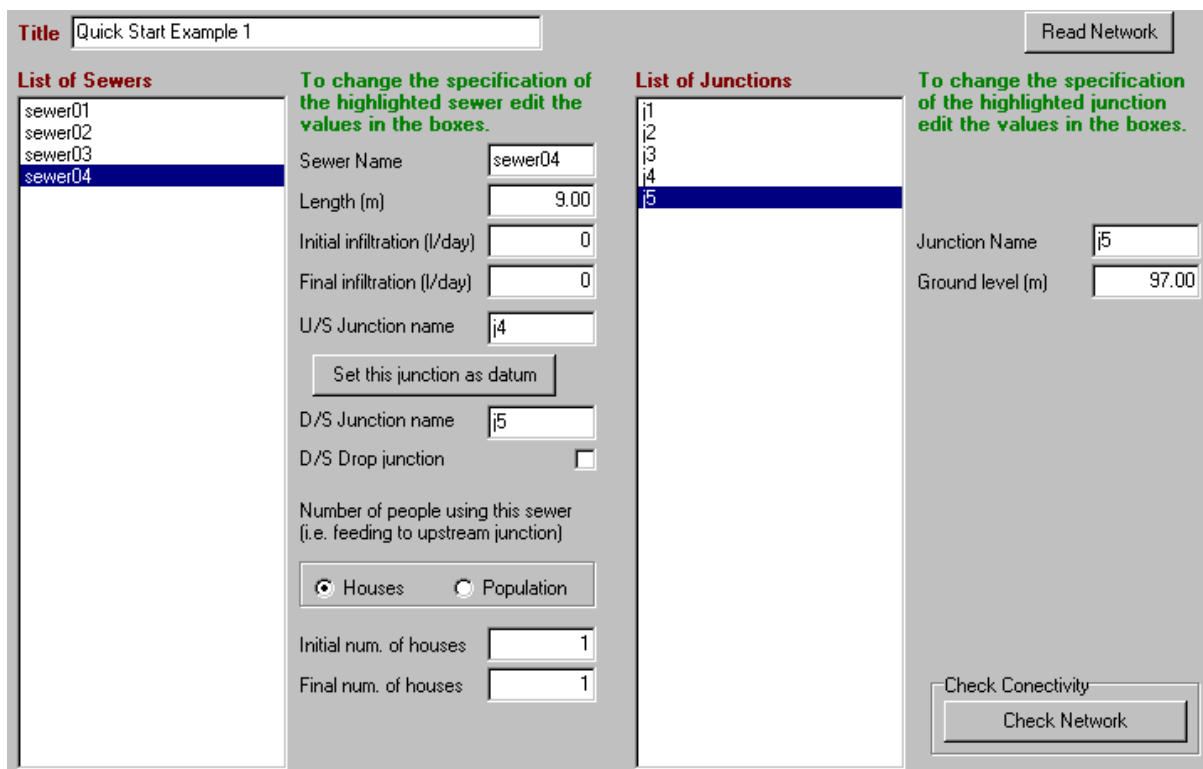
**Figure 4.57** Junction j5 data.

The datum junction must now be set. We will use the upstream end of the network for this, i.e. the upstream junction of sewer01, j1. Click on sewer01 in the **sewer** list, so that the screen looks something like Figure 4.49. Click on the “Set this junction as datum” button and the screen shown in Figure 4.58 will appear. Check the “Set this junction as the datum” box and then press the Apply button.



**Figure 4.58** Junction j5 data.

When the data are entered, the Screen Data Edit screen should appear as shown in Figure 4.59.



**Figure 4.59** Data for Example 1.

Next check that the network is connected correctly. On the Options menu make sure the "Delete unused junctions" item is ticked (this removes the unnecessary "J\_up" and "J\_down" junctions during the network check), then press the Check Network button. If all is well, a message will be displayed telling you that the network has passed its check. If it does not pass, go back through all of Figures 4.49-4.59 until

your screens look the same for each junction and sewer, and then check the network again.

Now save this network: on the File menu choose the first option Save Network. A standard Save Dialog will open allowing you to either choose an existing name or enter your own file name. For this example enter your own file name with the file extension “.snt” – for example, *myexample1.snt*. This will allow the file to be found more easily when you need to read back the data.

The entered network may now be viewed on the Visual Editor screen. Click the Visual Editor button. The network will look something like that shown in Figure 4.60, and it obviously does not represent what you have entered – the problem is that you have not entered position data for the junctions. The junctions have been given default locations and sewers drawn at default lengths, which means they are all drawn on top of each other! The junctions now need to be repositioned.



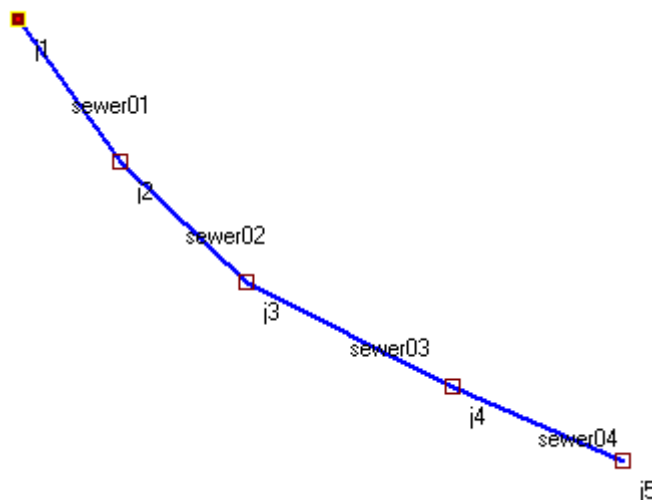
**Figure 4.60** View of the Quick Start Example 1 network before repositioning.

Click on the Edit Mode button and select the Junction option, as shown in Figure 4.61.



**Figure 4.61** Edit Mode button and selector.

Left click the mouse on a junction and, with the mouse button pressed, drag the junction to a new position. Repeat this on each junction until all have been positioned to give a view that represents the network – similar to that shown in Figure 4.62.



**Figure 4.62** View of the Quick Start Example 1 network after repositioning.

You can now view the results. To proceed to the Results Table press the button in the top toolbar. The solution for this sewer will be displayed as shown in Figure 4.63.

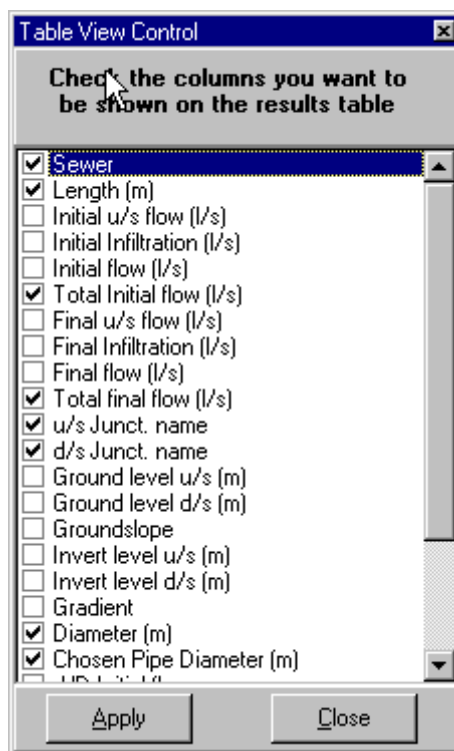
Initial water consumption (lcd) (litres/day)	<input type="text" value="50"/>	Minimum self-cleansing velocity (m/s)	<input type="text" value="0.50"/>	Return factor (%)	<input type="text" value="85"/>	Minimum flow (litres/s)	<input checked="" type="checkbox"/>	<input type="text" value="1.50"/>
Final water consumption (lcd) (litres/day)	<input type="text" value="120"/>	Minimum tractive tension (N/m <sup>2</sup> , Pa)	<input type="text" value="1.00"/>	Peak flow factor	<input type="text" value="1.80"/>	Minimum diameter (mm)	<input checked="" type="checkbox"/>	<input type="text" value="100"/>
Initial mean number of people per house	<input type="text" value="5"/>	G-Manning's n	<input type="text" value="0.0130"/>			Ground slope limiting	<input checked="" type="checkbox"/>	
Final mean number of people per house	<input type="text" value="5"/>	Minimum sewer cover (m)	<input type="text" value="0.40"/>	<input type="radio"/> Min Vel <input checked="" type="radio"/> Min Tau		<input checked="" type="radio"/> G-Manning <input type="radio"/> CW <input type="radio"/> Escrib		

Sewer	Length (m)	Total Initial flow (l/s)	Total final flow (l/s)	u/s Junct. name	d/s Junct. name	Diameter (m)	Chosen Pipe Diameter (m)	Depth u/s (m)	Depth d/s (m)
sewer01	10.00	1.500	1.500	j1	j2	0.100	0.100	0.500	0.500
sewer02	8.00	1.500	1.500	j2	j3	0.100	0.100	0.500	0.500
sewer03	7.00	1.500	1.500	j3	j4	0.100	0.100	0.500	0.500
sewer04	9.00	1.500	1.500	j4	j5	0.100	0.100	0.500	0.542
sewer05	20.00	1.500	1.500	j6	j5	0.100	0.100	0.542	0.542
sewer06	10.00	1.500	1.500	j7	j6	0.100	0.100	0.542	0.542
sewer07	10.00	1.500	1.500	j5	j8	0.100	0.100	0.542	0.542

**Figure 4.63** Results Table for Quick Start Example 1.

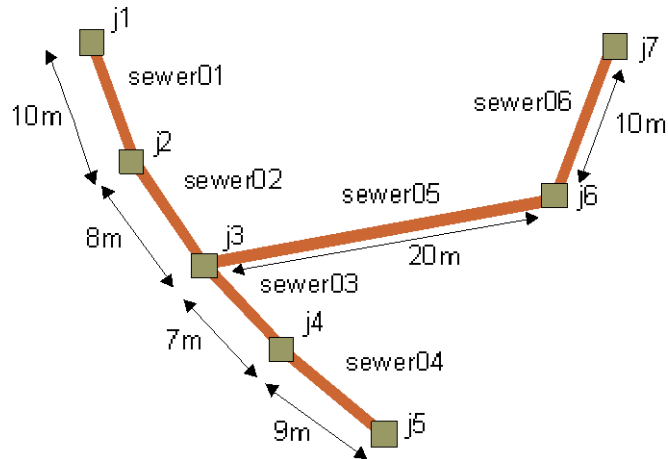
On your screen you will probably see many more columns of data. The full number of columns displayed can be reduced to avoid confusion or to display only the data you are interested in. Choose the View Menu and the “Select Columns to View” item. This will display the window shown in Figure 4.64, which is used to switch on or off the display of each column. With the list of column titles displayed, place a tick in the boxes next to the parameters you wish to display, and then press the Apply button.



**Figure 4.64** The Table View Control window.

The network data file for this example is supplied with the program under the filename *example01.snt*.

#### 4.7.2 Example 2 – Adding a branch sewer



**Figure 4.65** Example 2 sewer layout.

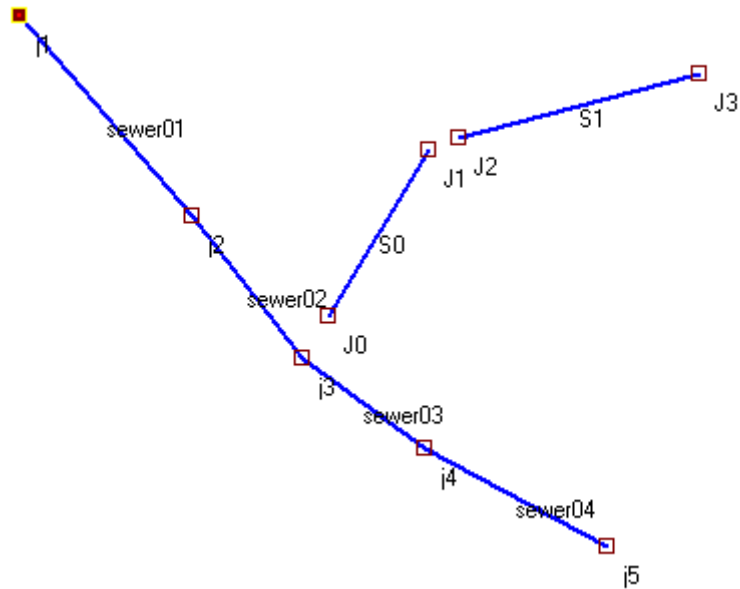
This example builds on the network described in Example 1 by attaching a sewer branch that joins at junction j3, as shown in Figure 4.65.

The first step is to read in the Example 1 data. If you completed Example 1 you may read your file; however to be sure to get the correct data, it is preferable to read the file *example01.snt* supplied with the program.

To read the data file choose the File menu and the “Read network” item. Choose the file “Example01.snt” in the Networks directory and read it in – the screen should now look similar to that shown in Figure 4.62.

On the Visual Edit screen click the Draw Mode button (the yellow pencil). Draw two lines on the screen in approximately the same place as sewer05 and sewer06 in Figure 4.65.

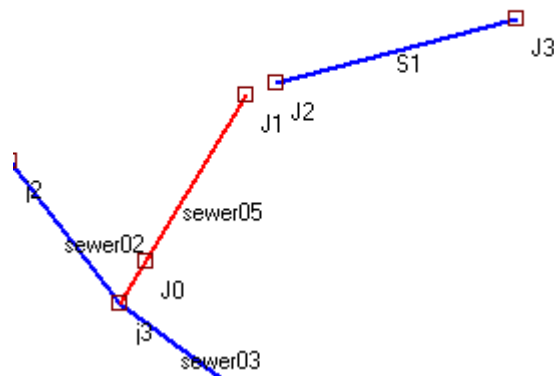
You should now have two new disconnected sewers, S0 and S1, and four new junctions J0-J3, as shown in Figure 4.66.



**Figure 4.66** The added sewers and junctions.

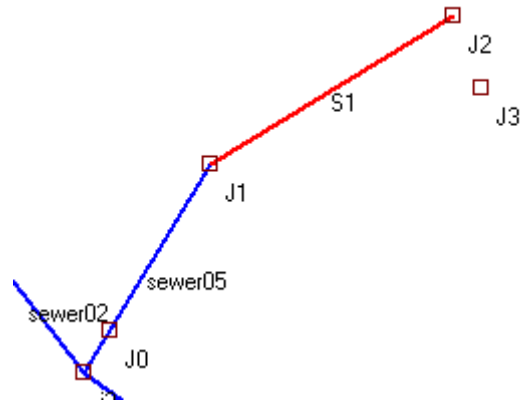
These new sewers need to be connected and renamed. In the Edit Mode choose the sewer option (Figure 4.61). Click on sewer S0; it will turn red and its details will be displayed on the right panel.

Change the sewer name to sewer05, its length to 20.0m and its downstream (D/S) junction to j3 (choosing this from the list). Also choose the Houses option and set initial and final number both to 1. The display should now look something like Figure 4.67.



**Figure 4.67** The sewer05 selected and connected to j3

Now select sewer S1 by clicking on it and change its name to sewer06, its length to 10m and select J1 for the D/S junction. Again choose the Houses option and set the initial and final number both to 1. Then choose “Junction” from the Item to select option (Figure 4.61) and click on junctions J1 and J2, one by one, dragging and repositioning them to give a better layout as necessary. The display should then look something like Figure 4.68.



**Figure 4.68** Sewers sewer05 and sewer06 connected and repositioned.

The last thing to do is to delete the unused junctions J0 and J3 and rename J1 and J2 setting their levels. To delete junction J0, make sure you are in Edit mode and have Junction chosen; now right click on the junction and it will be highlighted with a red circle and its details displayed on the right hand panel. On this panel click the “Delete Junction” button. Repeat this for junction J3.

To rename junction J1, stay in Edit mode, right click the junction until it is highlighted; now type the name “j6” in the name box and set the level to 98.0m. Click the “Apply Changes” button. Do the same for junction J2 changing its name to “j7” and its level to 99.0m.

You can now proceed to the Results Table by pressing the button in the top toolbar. The solution for this sewer will now be displayed.

The network data file for this example is supplied with the program under the filename *example02.snt*.

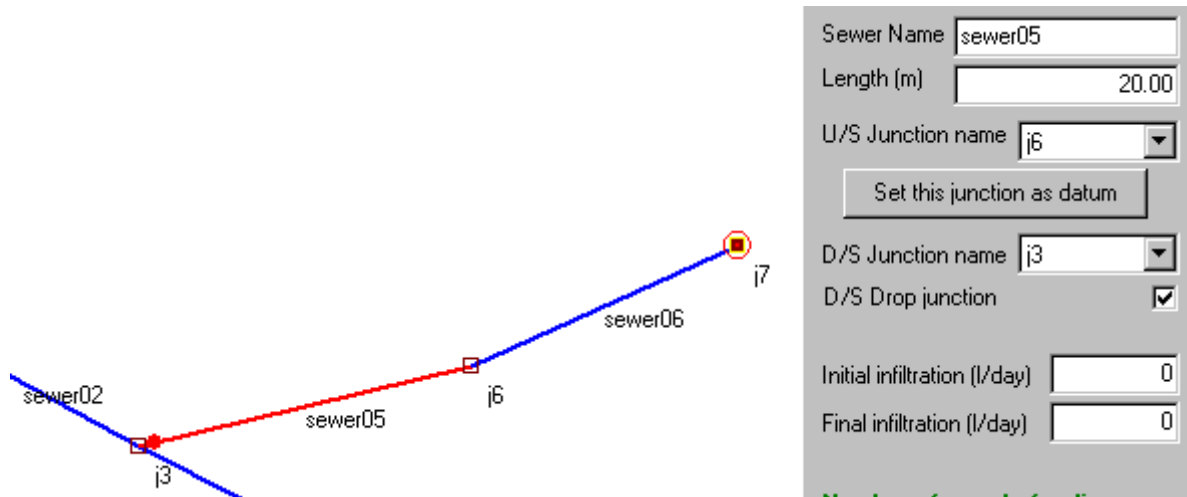
### 4.7.3 Example 3 - Branch conversion to two sub-networks

Example 2 has two branches that join at junction j3 and the whole network was calculated with all parts linked together. An alternative method of designing this type of sewer allows each branch to be designed as a separate network of defined sub-nets, as discussed in Section 4.1.3. This is useful when one of the sewers is to be designed to receive stormwater (see Section 3.3.3). We will use the data of Example 2 to demonstrate the use of sub-nets.

The network file supplied with the program for Example 2 is *example02.snt*. The first step is to read this in as a new network. We will convert this to have two sub-nets with one running from junction j1 to j5 and the other from j7 to j3. From this description there appears to be no difference between this layout and that in Example 2. This is so, but what we have done allows the second leg to be designed so that it may join at junction j3 at a different (higher) level if necessary. This may be desirable if the main leg is a previously designed sewer or one where levels are constrained for some reason.

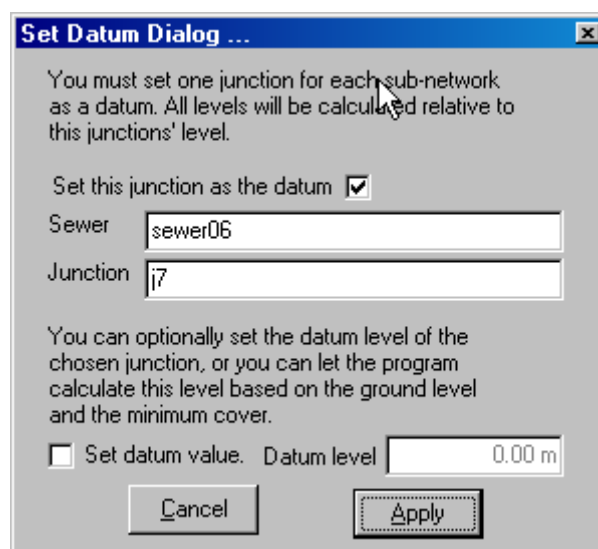


This alteration – allowing a sewer to join a junction at a different level – creates a “drop junction” at the downstream end of the sewer. Here, it is sewer05 that will have the drop junction at junction j3 on sewer02, so select sewer05 (change to Edit Mode, choose Sewer from the selection, then click on sewer05) so that it is highlighted in red (see Figure 4.69).



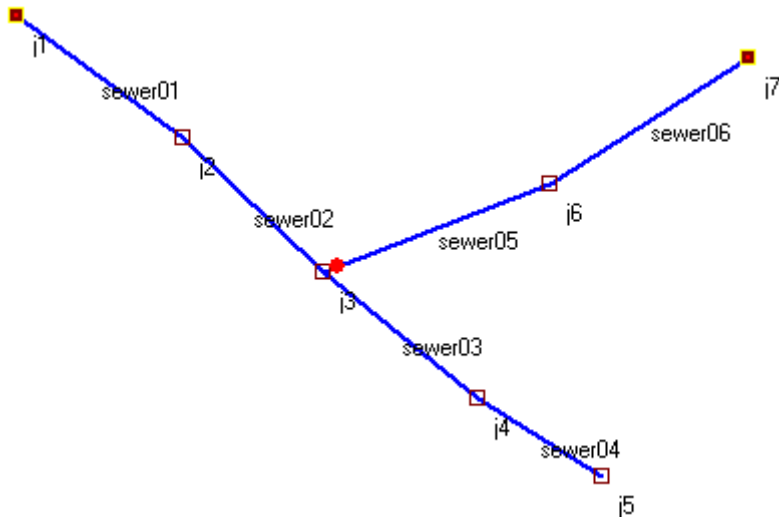
**Figure 4.69** Highlighted sewer05 marked with a drop junction.

On the details panel to the right check “D/S Drop junction”; a red spot will appear on sewer05 near junction j3, indicating the drop junction. This branch is now a sub-net of two sewers, sewer05 and sewer06. As it is a sub-net it requires a datum, so select sewer06 and select its upstream junction, j7, as the datum by clicking on the “Set this junction as datum” button and completing the window so that it appears as shown in Figure 4.70.



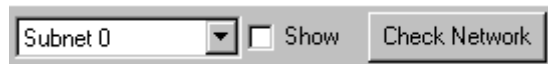
**Figure 4.70** Marking the datum for the sub-net.

Remove the highlights from the network by choosing the Options menu and then the Remove Highlights option. The network should now look something like Figure 4.71.



**Figure 4.71** Network for Example 3.

Each sub-net can be displayed. (It is very easy to see which is which in this example, but in more complex networks this may not be the case.) First the network must be checked by clicking the Check Network button on the top tool-bar of the Visual Editor screen (Figure 4.72.)

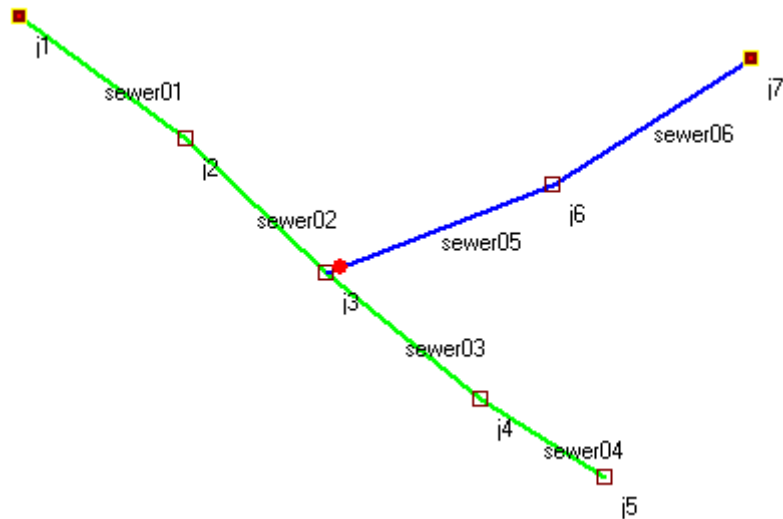


**Figure 4.72** Sub-net display controls.

If the network passes the check, then a message will appear to confirm this; if not, correct the network and check again. (Failures of the network check usually occur because a datum has not been set for one or more sub-nets, or the network loops in some area.) There will now be a list of sub-nets in the dropdown box of Figure 4.72, with the first, Subnet 0, displayed. To show the sub-net on the screen tick the Show box (Figure 4.73) and the display should look like that in Figure 4.74, with the selected sub-net shown in green.

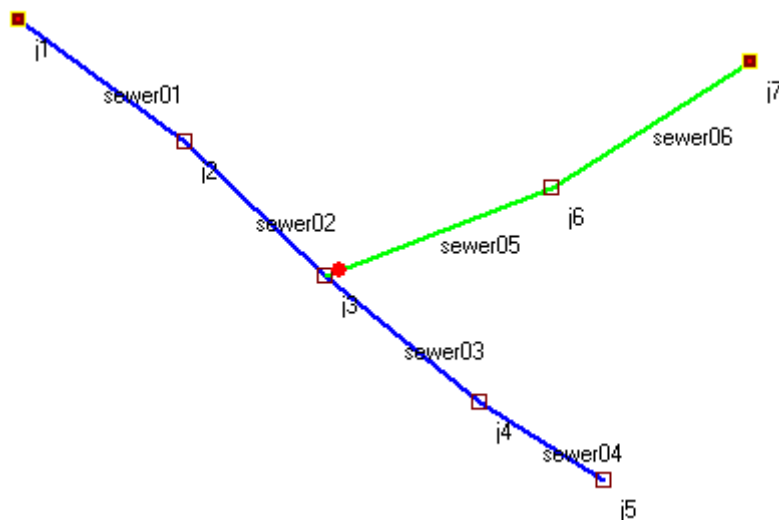


**Figure 4.73** Selecting Subnet 0 to be displayed.



**Figure 4.74** Subnet 0 displayed in green.

To highlight the second sub-net, simply select Subnet 1 from the dropdown list in Figure 4.73. This sub-net is now shown highlighted, as in Figure 4.75.



**Figure 4.75** Subnet 1 displayed in green.

#### 4.7.4 Example 4 – The UNCHS design example

This example is the UNCHS design example discussed in Appendix 2. The data for this network are supplied with the program in the file *unchs.snt*. Read this in and you should see the Data Entry/Edit form as shown in Figure 4.76. On the Visual Edit screen the display should be something like Figure 4.77. You can now proceed as described above in Examples 1-3.

Title: UNCHS Example Read Network

List of Sewers	To change the specification of the highlighted sewer edit the values in the boxes.	List of Junctions	To change the specification of the highlighted junction edit the values in the boxes.
B1-1	Sewer Name: B1-1	J1	Junction Name: J1
B1-2	Length (m): 10.00	J2	Ground level (m): 49.45
B1-3	Initial infiltration (l/day): 0	J3	
B1-4	Final infiltration (l/day): 0	J4	
B1-5	U/S Junction name: J1	J5	
B1-6	<input type="button" value="Set this junction as datum"/>	J6	
B1-7	D/S Junction name: J2	J7	
B1-8	D/S Drop junction: <input type="checkbox"/>	J8	
B1-9		J9	
B1-10		J10	
B1-11		J11	
B1-12		J12	
B1-13		J13	
B1-14		J14	
B1-15		J15	
B1-16		J16	
B1-17		J17	
		J18	

Figure 4.76 UNCHS example data.

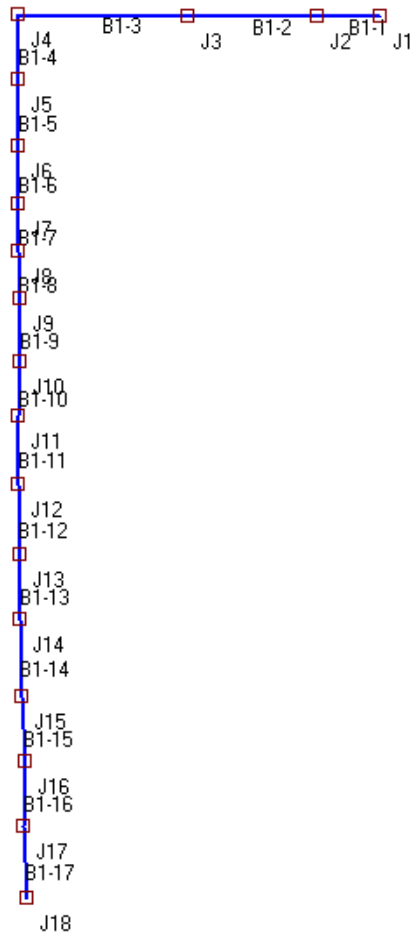


Figure 4.77 UNCHS example data as shown on Visual Edit screen.

# 5

## Simplified Sewerage in Practice

The practical aspects of simplified sewerage considered in this Section are construction (Section 5.1) and operation and maintenance (Section 5.2). These are extremely important for the overall sustainability of the system, which is briefly reviewed in Section 5.3.

### 5.1 SIMPLIFIED SEWER CONSTRUCTION

#### 5.1.1 The need for good construction practice

Good construction of a simplified sewer network is essential as poor construction inevitably leads to major operational problems, and even to system failure (Watson, 1995). Good practice is similar to that used for conventional sewerage (see, for example, Metcalf & Eddy Inc., 1981), but special care has to be given to laying small diameter sewers at shallow gradients. Good construction supervision is essential (lack of supervision generally leads to poor construction) but difficult to guarantee. One option that should be carefully considered is the training of small contracting companies inexperienced in simplified sewer construction. This is likely to be extremely beneficial – such training, combined with construction supervision, is probably the best way to ensure good construction.

#### 5.1.2 Sewer gradient and ground slope

The slope of the ground surface ( $S$ , m/m) may be (a) less than, (b) equal to, (c) greater than, or (d) much greater than, the minimum sewer gradient ( $I_{\min}$ , m/m) calculated from equation 2.25. Furthermore, the depth to the invert of the upstream end of the length of sewer under consideration may be (a) equal to, or (b) greater than, the minimum depth permitted ( $h_{\min}$ , m), which is given by:

$$h_{\min} = C + D \quad (5.1)$$

where  $C$  = minimum required cover, m (see Figure 5.1)  
 $D$  = sewer diameter, m

Minimum values of  $C$  used in Brazil are 20 cm for in-block sewers and those laid in front gardens, and 40 cm for those laid in pavements (sidewalks). Tayler (1996) recommends minimum values of  $C$  between 25 and 50 cm for concrete pipes laid in lanes and roads with 100 mm gravel or brick ballast bedding (Table 5.1).

**Table 5.1** Minimum cover for concrete pipes laid in lanes and roads (Tayler, 1996)

Road width (m)	Heaviest vehicle	Minimum cover (cm)
< 3	Motorcycle	25
3 – 4.5	Light car or van	35
4.5 – 6	Cars, horse-drawn carts, small trucks	40
> 6 <sup>a</sup>	Occasional trucks	50

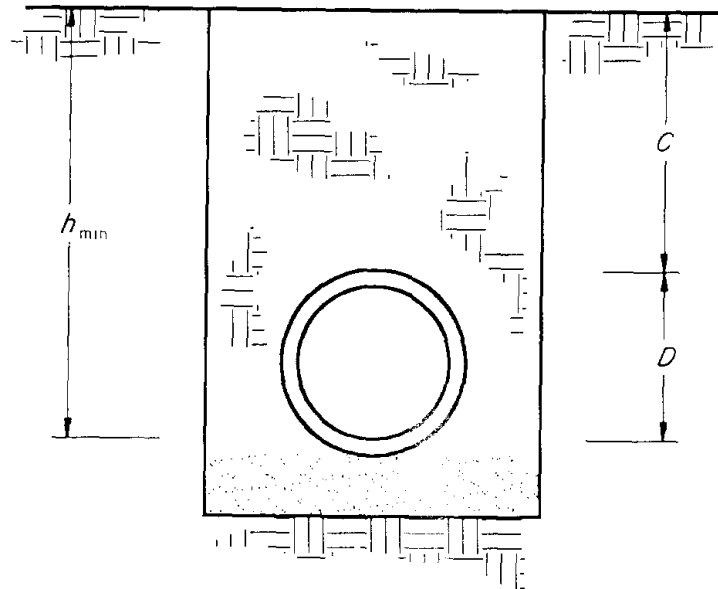
<sup>a</sup> Residential areas only

There are six combinations of sewer gradient and ground slope that are likely to be encountered in practice. These are (see Figure 5.2):

**Case 1.**  $S < I_{\min}$  and the invert depth of the upstream end of the sewer ( $h_1$ , m)  $\geq h_{\min}$ : choose  $i = I_{\min}$  and calculate the invert depth of the downstream end of the sewer ( $h_2$ , m) as:

$$h_2 = h_1 + (I_{\min} - S) L \quad (5.2)$$

where  $L$  = length of sewer under consideration, m.



**Figure 5.1** The minimum depth ( $h_{\min}$ ) to which a sewer is laid is the sum of the minimum depth of cover ( $C$ ) and the sewer diameter ( $D$ ).

Case	Solution
	$i = I_{\min}$ $h_2 = h_1 + (I_{\min} - S)L$
	$i = I_{\min}$ $h_2 = h_1$
	$i = S$ $h_2 = h_1 = h_{\min}$
	$i = S + (h_{\min} - h_1)/L \geq I_{\min}$ $h_2 = h_{\min}$
	$i = I_{\min}$ $h_2 = h_1 + (I_{\min} - S)L$
	$i_1 \ \& \ i_2 \geq I_{\min}$ $h_2 = h_{\min}$

**Figure 5.2** Ground slope and minimum sewer gradient: the six commonly encountered cases.

**Case 2.**  $S = I_{\min}$  and  $h_1 \geq h_{\min}$ : choose  $i = I_{\min}$  and  $h_2 = h_1$ .

**Case 3.**  $S > I_{\min}$  and  $h_1 = h_{\min}$ : choose  $i = S$  and  $h_2 = h_1$ .

**Case 4.**  $S > I_{\min}$  and  $h_1 > h_{\min}$ : choose  $h_2 = h_{\min}$  and calculate the sewer gradient from:

$$i = S + (h_{\min} - h_1)/L \quad (5.3)$$

subject to  $i \nless I_{\min}$ .

**Case 5.**  $S > I_{\min}$  and  $h_1 > h_{\min}$ : as Case 4, but an alternative solution is to choose  $i = I_{\min}$  and calculate  $h_2$  from equation 5.2. The choice between these alternative solutions is made on the basis of minimum excavation.

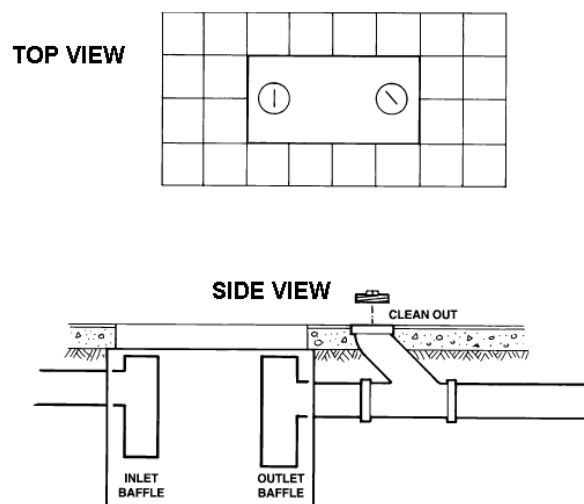
**Case 6.**  $S \gg I_{\min}$  and  $h_1 \geq h_{\min}$ : here, it is usually sensible to divide  $L$  into two or more substretches with  $h_2 = h_{\min}$  and  $i \ll S$  (but obviously  $\geq I_{\min}$ ) in order to minimize excavation. A drop manhole is placed at the substretch junction.

### 5.1.3 Grease/grit traps

If the kitchen wastewater contains an appreciable amount of fat and grease, it is desirable that a small individual household grease trap is installed to intercept the kitchen wastewater before it is discharged into the sewer (Figure 5.3). In Brasília Sarmiento (2000) found grease traps functioning well in 90 percent of households in the medium to low-income area of Vila Planalto. However, in general user education may be necessary to ensure people understand their operation and maintenance.

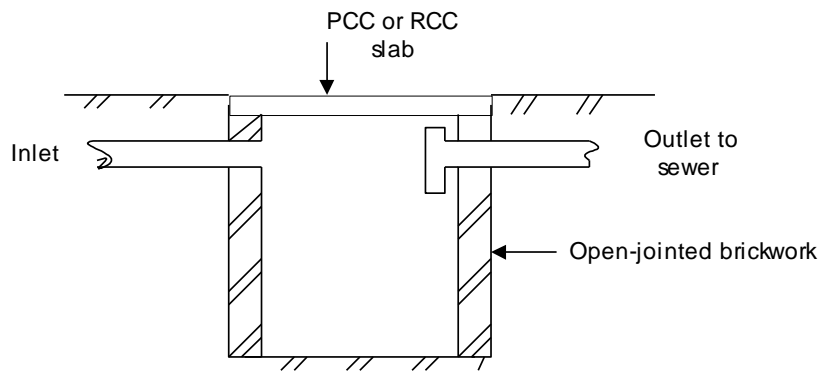
A related problem is that many householders drain water from yards and roofs to the sewer. This practice should be discouraged whenever possible, but it is difficult to avoid completely in areas where there are no alternative storm drainage facilities. Householders should be encouraged to provide a simple gully trap (Figure 5.4) on their property to both attenuate flows to the sewer and catch grit before it enters the sewer. This should ideally be located on a drain carrying only storm water and certainly upstream of the junction with the pipe from the WC. The trap should be built with open-jointed brickwork so that stormwater can percolate away. The base may be earth, no-fines concrete or sand-grouted brickwork, again to increase percolation.

Experience often suggests that people are often unaware of the importance of these traps and an effective campaign of user education will be necessary to ensure that they are cleaned at regular intervals. Of the two, the gully/grit trap will probably be of greater importance in ensuring that the sewer operates effectively, except where the sewer connection is from a restaurant or some other business that generates large quantities of grease.



**Figure 5.3** Individual household grease trap.





**Figure 5.4** Stormwater catchment gully.

#### 5.1.4 Sewer pipe materials

As shown in Appendix 3, hydrogen sulphide generation in simplified sewers can be expected to occur, and thus concrete and asbestos-cement should **not** be used as they will be corroded by the  $H_2S$  generated. In practice, therefore, plastic (normally PVC) or vitrified clay pipes should be used. Where possible, plastic pipes are to be preferred as they come in longer lengths and are more easily jointed properly, so that infiltration (i.e. groundwater ingress) is minimised.

#### 5.1.5 Sewer appurtenances

The important point to remember when considering the details of sewer appurtenances is that standards and design details should be related to location and function. Where condominiumal systems are laid at shallow depths, large expensive manholes can be replaced by simpler inspection chambers or junction boxes. These can be rectangular or circular in shape. Figure 5.4 shows a simple brick inspection chamber as used in Brazil. The Orangi Pilot Project in Pakistan has developed a system based on the use of cast-in-situ cylindrical concrete chambers. Another option is to use pre-cast cylindrical concrete sections, as shown in Figure 5.5. A more recent development is the all-plastic unit shown in Figure 5.6, which is manufactured by Tigre S.A., Joinvile, Brazil.<sup>1</sup>

Junction chambers are normally provided at every connection to the sewer, and inspection chambers at changes in direction and at intervals of no more than 30 m for condominiumal sewers and 100 m for public collector sewers. At changes of sewer diameter the sewers should be aligned invert to invert in junction/inspection chambers (other than at drop junctions).

<sup>1</sup> Address: Tigre S.A., Rua Xavantes 54, Atiradores, 89203-900 Joinvile, Santa Catarina, Brazil.  
Email: teletigre@tigre.com.br



**Figure 5.4** Simple brick junction chamber for simplified sewerage used in northeast Brazil.



**Figure 5.5** Junction chamber for simplified sewerage using larger diameter concrete pipes, used in Guatemala.



**Figure 5.6** Plastic junction chamber for simplified sewerage used in Brazil (manufactured by Tigre S.A.).

## 5.2 OPERATION AND MAINTENANCE

For successful operation of a simplified sewerage scheme, there must be an effective partnership between the community served and the sewerage authority (see Watson, 1995). In particular, it is important that both parties are clear about their duties and responsibilities.

As originally conceived by CAERN in northeast Brazil (see section 1.2), this meant that, early in the project planning stage, community meetings were organised by CAERN so that it could explain to the community how the system would work, and how responsibilities for operation and maintenance were to be allocated between the community and CAERN. In essence, the community members were to be responsible for O&M of the in-block sewer, and CAERN would assume responsibility for all ex-block (i.e. street) collector sewers and subsequent wastewater treatment. The community usually allocated each block resident the responsibility for sewer O&M for the length of sewer passing through his or her land, and this included the O&M of any junction boxes, and the clearance of any blockages.

However, this system of community O&M has not proved successful in the long term (see Watson, 1995), and currently different O&M procedures are used. For example, in the state of Pernambuco, COMPEA now contracts a small local contracting company to provide a maintenance team (often a technician engineer and two labourers) for a given periurban area served by simplified sewerage. This team works full-time in the designated area, and residents report any blockages, or other problem, to the team, which then attends to the problem. In Brasília and the

Federal District, CAESB organises its own maintenance teams, and these have vehicle-mounted water-jet units (Figure 5.7) to clean the sewers.

In villages in the state of Ceará covered by the KfW-funded Integrated Rural Sanitation Programme (SISAR), maintenance of the simplified sewer system and wastewater treatment plant (a single primary facultative waste stabilization pond) is done by one of the village residents after training by the Programme. The operator, who is paid one minimum salary (R\$ 120, around US\$ 70, per month) by the community, is also responsible for O&M of the piped water supply network – abstraction, treatment (including chlorination) and distribution. Village residents pay around R\$ 3 (~ US\$ 2) per household per month for both water and sewerage. The system works well if the operator is conscientious and if he is properly supervised by the President of the Residents' Association. Technical support is available from the SISAR office in the nearby city of Sobral. The programme currently covers 35 villages.

A slightly different approach is advocated by the Orangi Pilot Project in Pakistan. Here, the initiative to provide sewerage came from communities rather than the government. A key factor here was that government had failed to provide services so that people were used to taking responsibility for providing and managing local facilities. The OPP philosophy is that community members should take responsibility for financing and managing local 'internal' facilities, while the government is responsible for all aspects of public 'external' facilities. This approach can work reasonably well provided that all the stakeholders accept, and the charging structures reflect, this division of responsibilities. There is a need to define connection charges and tariffs in a way that recognises the costs incurred by both the central provider and the community groups that manage the local 'internal' systems. In practice, however, most water and sanitation authorities in Pakistan have not formally accepted this division of responsibilities and few community-built systems are officially recognised.



**Figure 5.7** Vehicle-mounted water-jet unit used for simplified sewer O&M in Brasília.

These examples suggest that community involvement in local sewerage facilities connected to higher order facilities managed by government is not without its problems. This aspect of sewer planning should be considered very carefully and it should not be assumed that community involvement will just happen. However, community management has such obvious advantages, in terms both of local 'ownership' of sewerage and making the best use of limited resources, that it should always be considered as early on in the project cycle as possible.

### 5.3 SYSTEM SUSTAINABILITY

The long-term sustainability of simplified sewer systems can be ensured by:

- a good partnership between the community served by simplified sewerage and the sewerage authority;
- good design;
- good construction;
- good maintenance; and
- an adequate, but affordable, tariff structure.

A good partnership between the community and sewerage authority is really essential, especially in periurban areas (Watson, 1995). Community education is almost always necessary (especially in relation to what residents should *not* dispose of via the simplified sewers; maintenance of any household grease or stormwater gully traps; how to report blockages and leaks). It is helpful if there is a well organised Residents' Association which can act as the primary point of contact between the sewerage authority and the community.

With regard to the tariff structure, 'adequate' refers to the sewerage authority receiving sufficient income from the monthly charges levied (see Section 1.2), although the authority may choose to operate a system of cross-subsidies whereby it levies higher charges for conventional sewerage so that it can charge less in poor areas served by simplified sewerage. Initial connection fees are likely to cause payment problems in poor areas, and these should be subsumed into the monthly charges. 'Affordable' refers to the ability of the residents to pay for the simplified sewerage service. In Brazil, for example, the Federal Government recommends that combined water and sewerage charges should not be greater than 7 percent of income; if this is taken as one minimum salary (R\$ 120 per month), then water and sewerage charges should be no more than R\$ 8 (~ US\$ 5) per month.



## REFERENCES AND FURTHER READING

### Further reading on Urban Health

Feachem, R.G., Bradley, D., Garelick, H. and Mara, D.D. (1983). ***Sanitation and Disease: Health Aspects of Excreta and Wastewater Management***. Chichester: John Wiley & Sons.

Hardoy, J.E., Cairncross, S. and Satterthwaite, D. (1990). ***The Poor Die Young: Health and Housing in Third World Cities***. London: Earthscan Publications Ltd.

Hardoy, J.E. and Satterthwaite, D. (1989). ***Squatter Citizen: Life in the Urban Third World***. London: Earthscan Publications Ltd.

Harpham, T., Lusty, T. and Vaughan, P. (1988). ***In the Shadow of the City: Community Health and the Urban Poor***. Oxford: Oxford University Press.

Harpham, T. and Tanner, M. (1995). ***Urban Health in Developing Countries: Progress and Prospects***. London: Earthscan Publications Ltd.

Tabibzadeh, I., Rossi-Espagnet, A. and Maxwell, R. (1989). ***Spotlight on the Cities: Improving Urban Health in Developing Countries***. Geneva: World Health Organization.

### Further reading on Simplified Sewerage

Recommended reading is denoted in the list of references by references given wholly in **bold**. Postal addresses and ISBNs (international standard book numbers) are also given for ease of obtaining these items. In addition the following are also recommended:

de Azevedo Neto, J.M. (1992). ***Innovative and Low Cost Technologies Utilized in Sewerage***. Environmental Health Program Technical Series No. 29. Washington, DC: Pan American Health Organization. Postal address: PAHO, 525 23rd Street NW, Washington DC 20037, USA.

Mara, D. (1996). ***Low-cost Sewerage***. Chichester: John Wiley & Sons. ISBN: 0 471 966916. Postal address: John Wiley & Sons, Baffins Lane, Chichester PO19 1UD, England.

Reed, R.A. (1995). ***Sustainable Sewerage: Guidelines for Community Schemes***. London: IT Publications. ISBN 1 85339 305 3. Postal address: IT Publications, 103-105 Southampton Row, London WC1B 4HH, England.

## References

**Note:** some key references listed below are available on the Internet – see the end of this Section for further details.

ABNT (1986). *Projeto de Redes Coletoras de Esgoto Sanitário*. Brazilian Standard No. 9649. Rio de Janeiro: Associação Brasileira de Normas Técnicas.

**Ackers, J.C., Butler, D. and May, R.W.P. (1996).** *Design of Sewers to Control Sediment Problems*. Report No. 141. London: Construction Industry Research and Information Association. ISBN: 086017 443 3. Postal address: CIRIA, 6 Storey's Gate, London SW1P 3AU, England.

Alfaro, R. (1997). *Linkages between Municipalities and Utilities: An Experience in Overcoming Urban Poverty*. Urban Environmental Sanitation Working Paper. Washington, DC: UNDP – World Bank Water and Sanitation Program.

Bakalian, A., Wright, A., Otis, R. and de Azevedo Neto, J. (1994). *Simplified Sewerage: Design Guidelines*. Water and Sanitation Report No. 7. Washington, DC: The World Bank.

Barnes, D., Bliss, P.J., Gould, B.W. and Valentine, H.R. (1981). *Water and Wastewater Engineering Systems*. London: Pitman Books Ltd.

**Black, M. (1994).** *Mega-Slums: The Coming Sanitary Crisis*. London: WaterAid. ISBN: 0 951 3466 1 X. Postal address: WaterAid, Prince Consort House, 27-29 Albert Embankment, London SE1 7UB, England.

Butler, D. and Pinkerton, B.R.C. (1987). *Gravity Flow Pipe Design Charts*. London: Thomas Telford Ltd.

Carlier, M. (1986). *Hydraulique Générale et Appliquée*. Paris: Editions Eyrolles.

Chanson, H. (1999). *The Hydraulics of Open Channel Flow*. London: Arnold.

Chaplin, S.E. (1999). Cities, sewers and poverty: India's politics of sanitation. *Environment and Urbanization* **11** (1), 145-158.

Chezy, A. (1776). Formule pour trouver la vitesse de l'eau conduit dans une rigole donnée. Dossier 847 (MS 1915) of the manuscript collection of the École National des Ponts et Chaussées, Paris. Reproduced in: Mouret, G. (1921). Antoine Chézy: histoire d'une formule d'hydraulique. *Annales des Ponts et Chaussées* **61**, 165-269.

Chow, V.T. (1959). *Open Channel Hydraulics*. New York, NY: McGraw-Hill Book Co.

Colebrook, C.F. (1939). Turbulent flow in pipes, with particular reference to the transition between the smooth and rough pipe laws. *Journal of the Institution of Civil Engineers* **11**, 133-156.



Cotton, A.P. and Saywell, D.L. (1998). *On-plot Sanitation for Low-income Urban Communities: Guidelines for Selection*. Loughborough University: University of Technology, WEDC.

Cunningham, A. (1883). Recent hydraulic experiments. *Minutes of the Proceedings of the Institution of Civil Engineers* **71**, 1-94.

de Andrade Neto, C.O. (1985). Uma solução eficaz e de baixo custo para o esgotamento sanitário urbano. *Engenharia Sanitária*, Rio de Janeiro **24** (2), 239-241.

de Melo, J.C. (1994). *Sistema Condominial de Esgotos: Razões, Teoria e Prática*. Brasília: Caixa Econômica Federal.

de Melo, J.C.R. (1985). Sistemas condominiais de esgotos. *Engenharia Sanitária*, Rio de Janeiro **24** (2), 237-238.

Diacon, D. (1997). *Slum Networking: An Innovative Approach to Urban Development*. Coalville, England: Building and Social Housing Foundation.

Dooge, J.C.I. (1992). The Manning formula in context. In *Channel Flow Resistance: Centennial of Manning's Formula* (ed. B.C. Yen), pp. 136-185. Littleton, CO: Water Resources Publications.

Escritt, L.B. (1984). *Sewerage and Sewage Treatment: International Practice* (ed. W.D. Haworth). Chichester: John Wiley & Sons.

Foley, S., Soedjarwo, A. and Pollard, R. (2000). *Case Study – Of the People, by the People, for the People: Community-based Sewer Systems in Melang, Indonesia*. Jakarta: World Bank/UNDP Water and Sanitation Program for East Asia and the Pacific.

Franceys, R., Pickford, J. and Reed, R. (1992). *A Guide to the Development of On-site Sanitation*. Geneva: World Health Organization.

Ganepola, P. (2000). Personal communication (National Housing Development Authority, Ministry of Housing and Urban Development, Colombo, Sri Lanka).

Ganguillet, E. and Kutter, W.R. (1869). Versuch zur Aufstellung einer neuen allgemeinen Formel für die gleichförmige Bewegung des Wassers in Canälen und Flüssen. *Zeitschrift des Osterreichischen Ingenieur – und Architekten-Vereines* **21**, (1), 6-25 and (2), 46-59. Translated into English by: Hering, R. and Trautwine, J.C. (1888 and 1891). *A General Formula for the Uniform Flow of Water in Rivers and Other Channels*. New York, NY: John Wiley & Sons.

Gauckler, P. (1867). Études théoriques et pratiques sur l'écoulement et le mouvement des eaux. *Comptes Rendus Hebdomadaires des Séances de l'Académie des Sciences* **64**, 818-822.

Gauckler, P. (1868). Du mouvement de l'eau dans les conduites. *Annales des Ponts et Chaussées* **15**, 229-281.

General Board of Health (1852). *Minutes of Information Collected with Reference to Works for the Removal of Soil Water or Drainage of Dwelling Houses and Public Edifices and for the Sewerage and Cleansing of the Sites of Towns*. London: Her Majesty's Stationery Office.

GHK Research and Training (2000). *Strategic Planning for Municipal Sanitation: A Guide* (Part C3: Tools for Sanitation Choice). London: GHK Research and Training.

Gidley, J.S. (1987). *Ericson, Nebraska Flat Grade Sewers*. Report No. WWBLC511. Morgantown, WV: National Small Flows Clearinghouse, University of West Virginia.

Guimarães, A.S.P. (1986). *Redes de Esgotos Simplificadas*. Brasília: Programa das Nações Unidas/Ministério do Desenvolvimento Urbano e Meio Ambiente.

Guimarães, A.S.P. (2000). Personal communication (GAIA Engenharia, Rio de Janeiro, Brazil).

Hagen, G.W. (1881). Neuere Beobachtung über die gleichförmige Bewegung des Wassers. *Zeitschrift für Bauwesen* **31**, 221-223.

HR Wallingford and Barr, D.I.H. (1994). *Tables for the Hydraulic Design of Pipes, Sewers and Channels*, 6th edition, volume 1. London: Thomas Telford Services Ltd.

Kolsky, P. (1998). *Storm Drainage: An Engineering Guide to the Low-cost Evaluation of System Performance*. London: IT Publications.

Lillywhite, M.S.T. and Webster, C.J.D. (1979). Investigations of drain blockages and their implications on design. *The Public Health Engineer* **7** (2), 53-60.

Luduvic, M. (2000). Personal communication (CAESB, Brasília DF, Brazil).

Luduvic, M., Neder, K.D. and Teixeira Pinto, M. (1999). *Produtividade e Eficiência na Implantação e Operação de Sistemas de Esgotamento Sanitário: A Experiência da CAESB*. Brasília: Companhia de Saneamento do Distrito Federal.

Machado Neto, J.C.O. and Tsutiya, M.T. (1985). Tensão trativa: um critério econômico de esgoto. *Revista DAE*, São Paulo, **45** (140), 73-87.

Manning, R. (1890). On the flow of water in open channels and pipes. *Transactions of the Institution of Civil Engineers of Ireland* **20**, 161-207.

**Mara, D. (1996). *Low-cost Urban Sanitation*. Chichester: John Wiley & Sons. ISBN: 0 471 96163 9. Postal address: John Wiley & Sons, Baffins Lane, Chichester PO19 1UD, England.**

Mara, D. (1999). Condominial sewerage in Victorian England. *Water and Environmental Manager* **4** (5), 4-6.

Metcalf & Eddy Inc. (1981). *Wastewater Engineering: Collection and Pumping of Wastewater*. New York, NY: McGraw-Hill Publishing Co.

Ministry of Urban Development (1995). *Manual on Sewerage and Sewage Treatment*, 2nd ed. New Delhi: Government of India Press.

Nigreiros, S. (1998). CAESB: A um passo da universalização dos serviços. *Saneamento Ambiental*, São Paulo (52), 20-29.

Nikuradse, J. (1933). *Strömungsgesetze in Rauchen Röhren*. Forschungsheft No. 361. Berlin: Verein Deutscher Ingenieure.

Otis, R.J. and Mara, D.D. (1985). *The Design of Small-bore Sewers*. TAG Technical Note No. 14. Washington, DC: The World Bank.

Pegram, G. and Palmer, I. (1999). *The Applicability of Shallow Sewer Systems in South Africa*. Report No. TT113/99. Pretoria: Water Research Commission.

Pomeroy, R.D. (1990). *The Problem of Hydrogen Sulphide in Sewers*. London: Clay Pipe Development Association.

Reed, R. and Vines, M. (1992a). *Reduced Cost Sewerage in Orangi, Karachi, Pakistan*. Loughborough, England: University of Technology (Water, Engineering and Development Centre).

Reed, R. and Vines, M. (1992b). *Reduced Cost Sewerage in the Community Development Project of Orangi, Karachi, Pakistan*. Loughborough, England: University of Technology (Water, Engineering and Development Centre).

Sarmiento, V. de B. A. (2000). Personal communication based on field surveys in Vila Planalto, Brasília DF and Rocas and Santos Reis, Natal RN (doctoral student, School of Civil Engineering, University of Leeds).

Sinnatamby, G.S. (1983). *Low-cost Sanitation Systems for Urban Peripheral Areas in Northeast Brazil*. PhD Thesis. Leeds: University of Leeds, Department of Civil Engineering.

**Sinnatamby, G.S. (1986). *The Design of Shallow Sewer Systems*. Nairobi: United Nations Centre for Human Settlements.** Postal address: UNCHS, PO Box 30030, Nairobi, Kenya.

Sinnatamby, G., McGarry, M. and Mara, D. (1986). Sewerage: shallow systems offer hope to slums. *World Water* 9, 39-41.

Strickler, A. (1923). *Beiträge zur Frage der Geschwindigkeits formel und der Rauigkeitszahlen für Ströme, Kanäle und geschlossene Leitungen*. Mitteilungen des Eidgenössischen Amtes für Wasserwirtschaft No. 16, Bern, Switzerland. Translated into English by: Roesgan, T. and Brownie, W.R. (1981). *Contributions to the Question of a Velocity Formula and Roughness data for Streams, Channels and Closed Pipelines*. Translation No. T-10. Pasadena, CA: California Institute of Technology, W.M. Keck Laboratory of Hydraulics and Water Resources.

Taylor, K. (1996). Low-cost sewerage systems in South Asia. In *Low-cost Sewerage* (ed. D. Mara), pp. 33-71. Chichester: John Wiley & Sons.

**Watson, G. (1995). *Good Sewers Cheap? Agency-Customer Interactions in Low-Cost Urban Sanitation in Brazil. Water and Sanitation Currents. Washington, DC: The World Bank.*** Postal address: Water and Sanitation Program, The World Bank, 1818 H Street NW, Washington DC 20433, USA.

Weisbach, J. (1855). *Die Experimental Hydraulik*. Freiburg: Engelhardt-Verlag.

Williams, G.P. (1970) Manning formula – a misnomer? *Journal of the Hydraulics Division, American Society of Civil Engineers* **96** (HY1), 193-199.

Williamson, J. (1951). The laws of flow in rough pipes: Strickler, Manning, Nikuradse and drag-velocity. *La Houille Blanche* **6** (5), 738-757.

World Bank (1993). *World Development Report 1993: Investing in Health*. New York, NY: Oxford University Press.

World Health Organization (1996). *Water Supply and Sanitation Sector Monitoring Report 1996: Sector Status as of 31 December 1994*. Geneva: WHO. [WHO is due to publish in late 2000/early 2001 the sector status as of 31 December 1999.]

Yao, K.M. (1974). Sewer line design based on critical shear stress. *Journal of the Environmental Engineering Division, American Society of Civil Engineers* **100** (EE2), 507-521.

Yen, B.C. (1992). Hydraulic resistance in open channels. In *Channel Flow Resistance: Centennial of Manning's Formula*. (ed. B.C. Yen), pp.1-135. Littleton, CO: Water Resources Publications.

Zaidi, S.A. (2000). *From the Lane to the City: the Impact of the Orangi Pilot Project's Low Cost Sanitation Model*. London: WaterAid.

### **Publications available on the Internet**

Go to the following website:

<http://www.sanigate.net/topics.php3>

and click on "Low-cost sewerage" to access on-line the following references listed above:

Bakalian *et al.* (1994),  
Foley *et al.* (2000),  
Sinnatamby (1986),  
Sinnatamby *et al.* (1986) and  
Watson (1995).

# Appendix 1

---

## Velocity of Flow Equations

In the 18th and 19th centuries three principal equations for the velocity of flow in open channels and pipes were developed. These are:

- (1) The **Chézy** equation,
- (2) The **Gauckler-Manning** equation, and
- (3) The **Darcy-Weisbach** equation.

The Chézy and Gauckler-Manning equations are related as the Ganguillet-Kutter equation for the Chézy coefficient of flow resistance includes the Kutter roughness coefficient,  $n$  which is identical to that used in the Gauckler-Manning equation.

The Darcy-Weisbach equation introduces the Darcy-Weisbach friction factor,  $f$ , which for turbulent flow in both rough and smooth pipes is given by the **Colebrook-White** equation used in modern sewer design (see, for example, Butler and Pinkerton, 1987).

To these three equations, we can add a fourth:

- (4) the **Escritt** equation,

also used in modern sewer design (Escritt, 1984).

The discussion that follows is based principally on Chow (1959), Yen (1992) and Chanson (1999).

### A1.1 THE CHÉZY EQUATION

Antoine Chézy developed his equation for the velocity of flow in 1775 (Chézy, 1776):

$$v = C_{\text{Ch}} r^{1/2} i^{1/2} \quad (\text{A1.1})$$

where  $C_{Ch}$  is the Chézy coefficient of flow resistance, defined by the later Ganguillet-Kutter equation (Ganguillet and Kutter, 1869) as:

$$C_{Ch} = \{23 + (0.0155/i) + (1/n)\} / \{1 + [23 + (0.0155/i) (n/r^{1/2})]\} \quad (A1.2)$$

where  $n$  = Ganguillet-Kutter roughness coefficient (dimensionless, but see Section A1.2.1).

## A1.2 THE GAUCKLER-MANNING EQUATION

As noted in Section 2.3, the Gauckler-Manning equation was developed by Gauckler (1867, 1868) and Manning (1890) (and also by Hagen, 1881; see Cunningham, 1883). The original form of the equation was:

$$v = C_{GM} r^{2/3} i^{1/2} \quad (A1.3)$$

where  $C_{GM}$  is the Gauckler-Manning coefficient of flow resistance, now taken as the reciprocal of  $n$  in the Ganguillet-Kutter equation ( $n$  is now known as Manning's  $n$ , rather than as Kutter's  $n$ ).

Strickler<sup>1</sup> (1923) gave the following equation for  $n$ :

$$n = d_{50}^{1/6} / 21.2 \quad (A1.4)$$

where  $d_{50}$  = median sediment diameter, m.

Strickler's equation for  $n$  is important as it was the first to attempt to relate the coefficient of roughness to sediment size, a concept later developed by Nikuradse (1933) in his use of an equivalent sand grain size as a measure of the effective roughness height ( $k_s$ ). Williamson (1951) used Nikuradse's adjusted data to give the following relationship between  $n$  and  $k_s$ :

$$n = k_s^{1/6} / 26.4 \quad (A1.5)$$

where  $k_s$  is in m (the value of  $k_s$  is commonly given in mm, but its unit in equations A1.5, A1.6, A1.7 and A1.10 is m).

### A1.2.1 Dimensions of $n$

The original metric version of the Gauckler-Manning equation (i.e. for  $v$  in m/s and  $r$  in m) is equation 2.13:

$$v = (1/n) r^{2/3} i^{1/2} \quad (2.13)$$

<sup>1</sup> In France and francophone countries the Gauckler-Manning equation is generally known as the Manning-Strickler equation with  $C_{GM}$  written as  $k$  (see Carlier, 1985).

The corresponding “English” version (for  $v$  in ft/s and  $r$  in ft) is:

$$v = (1.486/n) r^{2/3} i^{1/2} \quad (2.13a)$$

The numerical values of  $n$  used in equations 2.13 and 2.13a are the same (for example, 0.013 for slimed sewers). Thus, assuming that the two numerators (1 and 1.486) are pure numbers (i.e. dimensionless), the dimensions of  $n$  would be  $T L^{-1/3}$ ; Chanson (1999), for example, gives the units of  $n$  as  $s/m^{1/3}$ . However, as pointed out by Chow (1959), it is not reasonable for  $n$  to contain a dimension of time since it is a measure of surface roughness, and therefore should contain only some dimension of length.

If the numerators (1 and 1.486) are not considered pure numbers, but rather to contain  $\sqrt{g}$  (which has units of  $m^{1/2}/s$ ), then there are two possibilities (Chow, 1959):

*either* the numerators have the dimensions of  $L^{1/3} T^{-1}$  and  $n$  is dimensionless,

*or* the numerators contain only  $\sqrt{g}$ , so leaving the dimension of  $L^{1/6}$  for  $n$  (i.e.  $n$  has units of  $m^{1/6}$  or  $ft^{1/6}$ ).

In fact Chow (1959) shows that:

$$n = [\phi(r/k_s)] k_s^{1/6} \quad (A1.6)$$

where  $k_s$  is the Nikauradse equivalent sand grain size which has the dimension of  $L$ . Assuming that  $\phi(r/k_s)$  is dimensionless, equation A1.6 confirms that  $n$  has the dimension  $L^{1/6}$  (as indeed shown by equations A1.4 and A1.5, assuming their denominators are pure numbers).

Chow (1959) further points out that:

- (1) if  $n$  is considered dimensionless, then the conversion of the metric form of the equation to its English form involves conversion of the length dimension of the numerator ( $L^{1/3}$ ), that is the conversion of  $m^{1/3}$  to  $ft^{1/3}$ . Thus, since  $1 \text{ m} = 3.2808 \text{ ft}$ , the numerator in the English equation is  $3.2808^{1/3}$ , i.e. 1.486, and so equation 2.13a is obtained.
- (2) if  $n$  has the dimension of  $L^{1/6}$ , then its values in equation 2.13 and 2.13a cannot be the same as the factor  $3.2808^{1/6}$  ( $= 1.219$ ) must be involved. That is to say, if  $n$  is the value in metric units and  $n'$  that in English units, then

$$n' = 1.219 n \quad (2.13b)$$

and since  $n$  and  $n'$  have dimensions of  $L^{1/6}$ , the numerators now have the length dimension of  $L^{1/3 + 1/6}$ , i.e.  $L^{1/2}$ . The English numerator is thus  $3.2808^{1/2}$ , i.e. 1.811, and the English form of the equation is:

$$v = (1.811 / n') r^{2/3} i^{1/2} \quad (2.13c)$$

Substituting equation 2.13b:

$$\begin{aligned} v &= (1.811 / 1.219 n) r^{2/3} i^{1/2} \\ &= (1.486 / n) r^{2/3} i^{1/2} \end{aligned} \quad (2.13a)$$

Thus equation 2.13a can be obtained both on the assumption that  $n$  is dimensionless, and if it has the dimensions of  $L^{1/6}$ . As noted by Chow (1959), it was simpler for those working in the late 19th and early 20th centuries to take  $n$  as dimensionless and use the same value for it in both the metric and English forms of the equation (and so avoid the incongruity of using  $n = 0.013 \text{ m}^{1/6}$ , for example, in equation 2.13a which otherwise contains only English units). However, from the point of view of modern fluid mechanics, it is clearly preferable to consider that  $n$  is related to the Nikuradse equivalent sand grain size and thus, from equation A1.5, has dimensions of  $L^{1/6}$ .

### A1.2.2 A modern form for the Gauckler-Manning equation

Dooge (1992) completes his erudite review of Manning's equation with the following paragraph (which we might amend only to refer to both Gauckler and Manning):

"If Manning were with us today he would be pleased to learn that his formula was still being widely used. However, he would probably argue trenchantly that the formula should be written in the form:

$$v = M (r / k_s)^{1/6} (g r i)^{1/2} \quad [(A1.7)]$$

so that  $M$  would be a dimensionless constant varying slightly with the shape of the channel. Manning would also probably recommend strongly a carefully planned series of experiments to determine  $M$  for the range of shapes of cross section important in engineering practice. He would be right to so argue in both cases."

From equations 2.13 and A1.5 the value of  $M$  in equation A1.7 can be shown to be 8.4.

## A1.3 THE COLEBROOK-WHITE EQUATION

The Darcy-Weisbach equation, developed by Weisbach (1855) and the basis of the modern Colebrook-White equation, is given by:

$$v = \sqrt{(8g / f)} r^{1/2} i^{1/2} \quad (A1.8)$$

where  $f$  is the dimensionless Darcy friction coefficient. Inspection of equation A1.8 shows that the term  $\sqrt{(8g / f)}$  is the Chézy coefficient,  $C_{Ch}$  (see equation A1.1).

The definition of  $f$  has occupied many hydraulic engineers over the past 150 years, and equations for laminar, transient and turbulent flow were developed to relate  $f$  to the Reynold's number ( $R_e$ ), defined as:



$$R_e = vr / \nu \quad (A1.9)$$

where  $\nu$  = kinematic viscosity,  $m^2/s$ .

For turbulent flow ( $R_e > 25\,000$ ) in both smooth and rough pipes  $f$  is given by the Colebrook-White equation (Colebrook, 1938; see also Butler and Pinkerton, 1987 and H R Wallingford and Barr, 1994):<sup>2</sup>

$$1/f^{1/2} = -2 \log [(k_s/14.8r) + (0.63/R_e f^{1/2})] \quad (A1.10)$$

## A1.4 THE ESCRITT EQUATION

Escrutt (1984) gives his equation for wastewater flow in circular sewers in the form :

$$v = 26.738 D^{0.62} i^{1/2} \quad (A1.11)$$

where  $v$  = velocity of flow, metres per *minute*

$D$  = diameter, *millimetres*

Changing the units of  $v$  to  $m/s$  and  $D$  to  $m$  and writing  $D$  as  $4r$  gives:

$$v = (1 / 0.013) r^{0.62} i^{1/2} \quad (A1.12)$$

The hydraulic radius,  $r$  in this equation is “not the cross-sectional area divided by the wetted perimeter, but averaged, with remarkable accuracy, the cross-sectional area divided by the sum of the wetted perimeter and one-half the width of the water-to-air surface” (Escrutt, 1984), that is:<sup>3</sup>

$$r = a / [p + (b/2)] \quad (A1.13)$$

Equation A1.12 shows the Escrutt equation to be a variant of the Gauckler-Manning equation, with  $n$  taken as 0.013 for slimed sewers, and with  $r$  defined by equation A1.13 and having the exponent 0.62 rather than  $2/3$ .

<sup>2</sup> Different values of the constants 14.8 and 0.63 in equation A1.10 are used in the Colebrook-White equation given by both Butler and Pinkerton and HR Wallingford and Barr, as these authors give the equation in terms of  $D$  rather than  $r$  ( $D = 4r$ ), and they define  $R_e$  as  $vD/\nu$  rather than as  $vr/\nu$ .

<sup>3</sup> Based on their measurements on the Mississippi River, Humphreys and Abbot (1861; cited in Dooge, 1992) give an equation for the velocity of flow in large streams which contains the term  $a / (p + b)$ .



# Appendix 2

---

## Comparative Simplified Sewer Design Trials

The simplified sewer design examples given by UNCHS (Sinnatamby, 1986) and the World Bank – UNDP (Bakalian *et al.*, 1994) were used to compare the results obtained using (a) the Gauckler-Manning equation, (b) the Colebrook-White equation, and (c) the Escripp equation, which are described in Appendix 1.

### **A2.1 UNCHS DESIGN EXAMPLE**

The design example for the in-block sewer shown in Figure A2.1 (Sinnatamby, 1986) was used to compare the results obtained with the three velocity of flow equations. The original design (Table A2.1) was based on achieving at peak flow a self-cleansing velocity of 0.5 m/s, rather than a minimum tractive tension of 1 Pa. The results of the comparative design trial are given in the Table A2.2 and A2.3 for the three equations both for a minimum self-cleansing velocity of 0.5 m/s (using the design equations given in Mara, 1996) (Table A2.2) and for a minimum tractive tension of 1 Pa (using the design equations given in Section 2) (Table A2.3).

#### **Minimum self-cleansing velocity (Table A2.2)**

The calculated values of the sewer diameters are all < 100 mm, which is therefore the diameter which would be selected for the whole of the in-block sewer. The values calculated from the Gauckler-Manning and Escripp equations are within 1-4 mm, with the former giving the smaller values. The diameters calculated from the Colebrook-White equation are the largest, and larger than the Gauckler-Manning diameters by up to 12 mm.

#### **Minimum tractive tension (Table A2.3)**

The calculated diameters are larger than those calculated for the minimum self-cleansing velocity (Table A2.1) by up to 9 mm (but  $I_{\min}$  is a third lower). The comments made above for minimum self-cleansing velocity are equally applicable here. An additional point is that for three sewer sections (B1-1, B1-2 and B1-3) the Colebrook-White equation gives a diameter just above 100 mm, whereas those

given by the other two equations are below it – thus the output of the PC-based design must include calculated diameters as well as selected (i.e. commercially available) diameters, so that the output can be manually checked and adjusted (here, in the case of the Colebrook-White calculated diameter of 102 mm, the diameter chosen by manual checking would be 100 mm, rather than the next available size of 150 mm).

Examination of Tables A2.2 and A2.3 indicates that the preferred velocity of flow equation is the Gauckler-Manning equation.

## **A2.2 WORLD BANK – UNDP DESIGN EXAMPLE**

The design example, given in Bakalian *et al.* (1994) and detailed below, was also used to compare the three equations for a minimum tractive tension of 1 Pa.

### **Design example**

Design an interceptor sewer for a town with a current population of 10,800 which is expected to grow to 14,400 in 10 years time. *Data:* water consumption, 250 litres per person per day; return factor, 0.80; peak flow factor, 1.8.

The results of the comparative design trial are as follows:

(a) **Gauckler-Manning equation** ( $n = 0.013$ )

Sewer gradient: 0.001 m/m

Sewer diameter: 392 mm

(b) **Colebrook-White equation** ( $k_s = 1.5$  mm)

Sewer gradient: 0.001 m/m

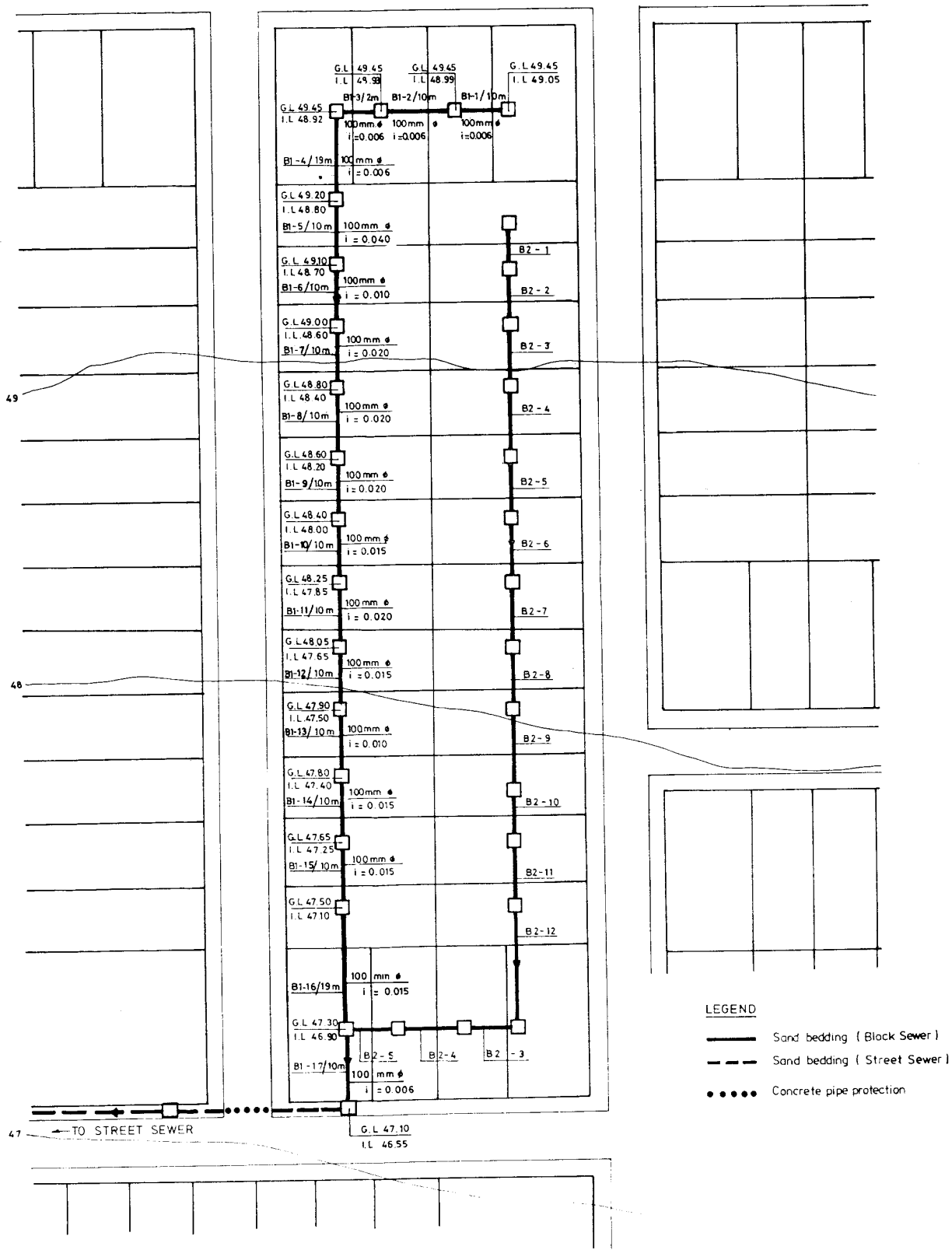
Sewer diameter: **403** mm

(c) **Eschritt equation**

Sewer gradient: 0.0009 m/m

Sewer diameter: **403** mm

As with the UNCHS design example, the Colebrook-White and Eschritt equations give a diameter just above a standard pipe size (400 mm), and the Gauckler-Manning equation one just below it – confirming (a) that the PC-based design output requires manual checking to avoid the selection of the next largest diameter (in this case 450 mm); and (b) that the Gauckler-Manning equation is the preferred design equation.



**Figure A2.1** In-block sewer layout for UNCHS design example. *Source:* Sinnatamby (1986).

**Table A2.1 Hydraulic calculations for UNCHS in-block simplified sewer design example shown in Figure A2.1 using the Gauckler-Manning equation with  $n = 0.013$ , for a minimum self-cleansing velocity of 0.5 m/s and a minimum flow of 2.2 l/s**

Sewer reference (1)	Length (2)	Number of houses served (3)	Flow upstream (4)	Flow along the stretch (5)	Flow down stream (6)	Ground level		Invert level		Difference in invert level (11)	Gradient (12)	Diameter (13)	Flow at full section (14)	Velocity of flow (15)	Depth of sewer		Depth of down-stream chamber (18)
						Up-stream (7)	Down-stream (8)	Up-stream (9)	Down-stream (10)						Up-stream (16)	Down-stream (17)	
B1-1	10	1	2.2	-	2.2	49.45	49.45	49.05	48.99	0.06	0.06	100	4.03	0.50	0.40	0.46	0.46
B1-2	10	2	2.2	-	2.2	49.45	49.45	48.99	48.93	0.06	0.06	100	4.03	0.50	0.46	0.52	0.52
B1-3	2	3	2.2	-	2.2	49.45	49.45	48.93	48.92	0.01	0.06	100	4.03	0.50	0.52	0.53	0.53
B1-4	19	4	2.2	-	2.2	49.45	49.20	48.92	48.80	0.12	0.06	100	4.03	0.50	0.53	0.40	0.40
B1-5	10	5	2.2	-	2.2	49.20	49.10	48.80	48.70	0.10	0.010	100	5.22	0.55	0.40	0.40	0.40
B1-6	10	6	2.2	-	2.2	49.10	49.00	48.70	48.60	0.10	0.010	100	5.22	0.55	0.40	0.40	0.40
B1-7	10	7	2.2	-	2.2	49.00	48.80	48.60	48.40	0.20	0.020	100	7.40	0.80	0.40	0.40	0.40
B1-8	10	8	2.2	-	2.2	48.80	48.60	48.40	48.20	0.20	0.020	100	7.40	0.80	0.40	0.40	0.40
B1-9	10	9	2.2	-	2.2	48.60	48.40	48.20	48.00	0.20	0.020	100	7.40	0.80	0.40	0.40	0.40
B1-10	10	10	2.2	-	2.2	48.40	48.25	48.00	47.85	0.15	0.015	100	6.40	0.73	0.40	0.40	0.40
B1-11	10	11	2.2	-	2.2	48.25	48.05	47.85	47.65	0.20	0.020	100	7.40	0.80	0.40	0.40	0.40
B1-12	10	12	2.2	-	2.2	48.05	47.90	47.65	47.50	0.15	0.015	100	6.40	0.73	0.40	0.40	0.40
B1-13	10	13	2.2	-	2.2	47.90	47.80	47.50	47.40	0.10	0.010	100	5.22	0.55	0.40	0.40	0.40
B1-14	10	14	2.2	-	2.2	47.80	47.65	47.40	47.25	0.15	0.015	100	6.40	0.73	0.40	0.40	0.40
B1-15	10	15	2.2	-	2.2	47.65	47.50	47.25	47.10	0.15	0.015	100	6.40	0.73	0.40	0.40	0.40
B1-16	19	16	2.2	-	2.2	47.50	47.30	47.10	46.90	0.20	0.011	100	5.47	0.70	0.40	0.40	0.54
B1-17	10	32	2.2	-	2.2	47.30	47.10	46.76	46.70	0.06	0.006	100	4.03	0.50	0.54	0.40	0.55

Notes: (a) Minimum gradient = 0.006

(b) Original design example used  $q_{\min} = 2.2$  l/s, rather than the currently recommended value of 1.5 l/s.

(c) Sewer diameters given are those rounded up to next available diameter, see Table A2.2 for calculated values.

Source: Sinnatamby (1986).

**Table A2.2 Hydraulic calculations for UNCHS in-block simplified sewer design example using the Gauckler-Manning, Colebrook-White and Escritt equations for a minimum self-cleansing velocity of 0.5 m/s and a minimum flow of 2.2 l/s**

Sewer section (Figure A2.1)	Sewer gradient <sup>a</sup> (m/m)	Sewer diameter (mm) <sup>b</sup> calculated from		
		G-Manning equation <sup>c</sup>	C-White Equation <sup>d</sup>	Escritt equation <sup>e</sup>
B1-1	0.006	81	93	82
B1-2	0.006	81	93	82
B1-3	0.006	81	93	82
B1-4	0.013	75	80	71
B1-5	0.010	73	85	75
B1-6	0.010	73	85	75
B1-7	0.020	64	74	65
B1-8	0.020	64	74	65
B1-9	0.020	64	74	65
B1-10	0.015	68	78	69
B1-11	0.020	64	74	65
B1-12	0.015	68	78	69
B1-13	0.010	73	85	75
B1-14	0.015	68	78	69
B1-15	0.015	68	78	69
B1-16	0.011	73	84	74
B1-17	0.020	64	74	65

<sup>a</sup> Minimum gradient = 0.006.

<sup>b</sup> Sewer diameters given are those calculated rather than rounded up to next available diameter.

<sup>c</sup> Equation 2.13 with  $n = 0.013$ .

<sup>d</sup> Equations A1.8 and A1.10 with  $k_s = 1.5$  mm.

<sup>e</sup> Equations A1.12 and A1.13.

**Table A2.3 Hydraulic calculations for UNCHS in-block simplified sewer design example using the Gauckler-Manning, Colebrook-White and Escritt equations for a minimum tractive tension of 1 Pa and a minimum flow of 2.2 l/s**

Sewer section (Figure A2.1)	Sewer gradient <sup>a</sup> (m/m)	Sewer diameter (mm) <sup>b</sup> calculated from		
		G-Manning equation <sup>c</sup>	C-White equation <sup>d</sup>	Escritt Equation <sup>e</sup>
B1-1	0.004	87	<b>102</b>	90
B1-2	0.004	87	<b>102</b>	90
B1-3	0.004	87	<b>102</b>	90
B1-4	0.013	70	80	71
B1-5	0.010	73	85	75
B1-6	0.010	73	85	75
B1-7	0.020	64	74	65
B1-8	0.020	64	74	65
B1-9	0.020	64	74	65
B1-10	0.015	68	78	69
B1-11	0.020	64	74	65
B1-12	0.015	68	78	69
B1-13	0.010	73	85	75
B1-14	0.015	68	78	69
B1-15	0.015	68	78	69
B1-16	0.011	73	84	74
B1-17	0.020	64	74	65

<sup>a</sup> Minimum gradient = 0.004

<sup>b</sup> Sewer diameters given are those calculated rather than rounded up to next available diameter.

<sup>c</sup> Equation 2.13 with  $n = 0.013$ .

<sup>d</sup> Equations A1.8 and A1.10 with  $k_s = 1.5$  mm.

<sup>e</sup> Equations A1.12 and A1.13.



# Appendix 3

## Hydrogen Sulphide Generation

Hydrogen sulphide generation in sewers leads to microbial corrosion of the crown of concrete and asbestos – cement sewers (Figure A3.1). The likelihood of H<sub>2</sub>S generation is given by Pomeroy's (1990) **Z** factor:

$$Z = 3 (\text{BOD}_5) (1.07)^{T-20} i^{-1/2} q^{-1/3} (p/b) \quad (\text{A3.1})$$

where BOD<sub>5</sub> = 5-day, 20°C biochemical oxygen demand of the wastewater, mg/l

*T* = temperature, °C

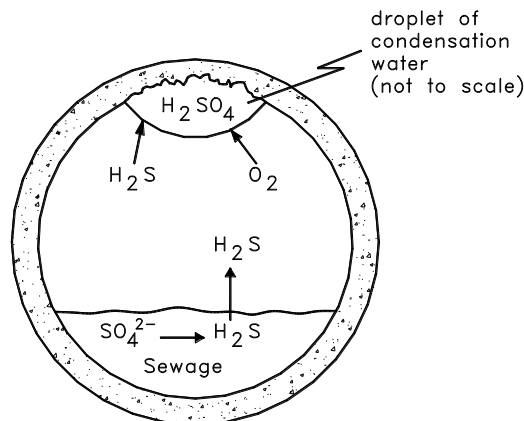
*i* = sewer gradient, m/m

*q* = wastewater flow, l/s

*p* = wetted perimeter, m

*b* = breadth of flow (see Figure 2.1), m

and 3 is the conversion factor resulting from changing the units of *q* from ft<sup>3</sup>/s in Pomeroy's original equation to l/s.



**Figure A3.1** Microbially induced corrosion of the crown of concrete or asbestos cement sewers: sulphates in the wastewater are reduced anaerobically by sulphate-reducing bacteria to hydrogen sulphide, some of which leaves the wastewater to raise its partial pressure in the atmosphere above the flow (Henry's law), and then some of this H<sub>2</sub>S goes into solution (Henry's law again) in droplets of condensation water clinging to the sewer crown – this H<sub>2</sub>S is oxidized by the aerobic bacterium *Thiobacillus thioparus* to sulphuric acid (H<sub>2</sub>SO<sub>4</sub>), which corrodes the concrete. Sewer crown collapse within 10-20 years is not uncommon.

The value of **Z** calculated from equation A3.1 is used diagnostically as follows:

**Z** < 5000: H<sub>2</sub>S generation unlikely

5000 < **Z** < 10 000: H<sub>2</sub>S generation possible

**Z** > 10 000: H<sub>2</sub>S generation very likely

With simplified sewerage, hydrogen sulphide generation can be expected to be a common problem. For example, for a flow of 1.5 l/s of wastewater with a BOD<sub>5</sub> of 250 mg/l at 25°C in a sewer laid at 1 in 214 and flowing at a proportional depth of flow of 0.2, **Z** can be calculated as follows, using equations 2.4, 2.6 and 2.8 to calculate *p/b* for *d/D* = 0.2:

$$\theta/2 = \cos^{-1} [1 - 2 (d/D)]$$

$$= 0.927 \text{ radian}$$

$$p/b = (\theta/2)/\sin (\theta/2)$$

$$= 1.159$$

$$\mathbf{Z} = 3 \times 250 (1.07)^5 (1/214)^{-1/2} (1.5)^{-1/3} (1.159)$$

$$= 16\,000$$

Thus H<sub>2</sub>S generation is very likely, and this is why the small diameter pipes used in simplified sewerage schemes should normally be of either vitrified clay or PVC.